



ALPHATRON
Marine



AlphaDepth

Depth Repeater

Installation and Operation Manual

www.jrc-world.com

Contents

I Preface.....	4
I.1 Revision History.....	4
I.2 Glossary.....	4
I.2.1 Definitions.....	4
I.2.2 Abbreviations.....	5
I.3 Norms and Standards.....	6
II Safety Information.....	7
II.1 Pictorial Indication.....	7
II.2 Cautions.....	7
II.3 Notices.....	7
II.4 Warranty.....	8
II.5 Storage.....	8
III Introduction.....	9
1 Installation Instructions.....	10
1.1 Mechanical Installation.....	10
1.1.1 Supplied Parts.....	10
1.1.2 Dimensions.....	10
1.1.3 Mounting Instrument.....	10
1.1.4 Fitting Instrument Mounting Frame.....	11
1.1.5 Fitting Instrument Water Seal.....	11
1.1.6 Instrument Electric Connections.....	12
1.1.7 Cable.....	13
1.1.8 Cable Preparation.....	13
1.1.8.1 Cable Preparation Sending Sides.....	13
1.1.8.2 Cable Preparation Receiving Sides.....	14
1.1.9 Grounding Instrument.....	14
1.1.10 Instrument Power Supply.....	14
1.1.11 Serial Interfaces.....	15
1.1.12 Serial Connection.....	17
1.1.13 Relay.....	18
1.1.14 Connecting Serial Ports.....	18
1.1.15 Connecting Dimmer.....	19
1.2 Software Installation.....	20
1.2.1 Selecting Active Software.....	20
1.2.1.1 Software applications.....	20
1.2.2 Software Updates.....	21
1.2.3 Watchdog Protection.....	21
2 Operation.....	22
2.1 Power.....	22
2.2 Main Screen.....	22
2.3 Menu Handling.....	24
2.3.1 Default Values AlphaLine Instrument.....	25
2.4 Indication Handling.....	26

2.5 Settings.....	30
2.5.1 Generic Settings Menu.....	30
2.5.1.1 Touch Screen Calibration (TOUCH CAL).....	31
2.5.1.2 Cleaning Display (CLEAN MODE).....	32
2.5.1.3 Change Theme (THEME).....	33
2.5.1.4 Change Date and Time (DATE/TIME).....	34
2.5.1.5 About the AlphaLine instrument (ABOUT).....	35
2.5.1.6 Change Range Settings (RANGE SCALE).....	36
2.5.1.7 Unit Selection (UNITS).....	37
2.5.1.8 Application Offset (OFFSET).....	38
2.5.1.9 Test Function (TEST).....	39
2.5.2 Advanced Settings Menu (ADV SET).....	40
2.5.2.1 Central Dimming (CNTRL DIM).....	41
2.5.2.2 Ethernet Configuration (ETH CONFIG).....	42
2.5.2.3 Serial Port Configuration (UART CONFIG).....	43
2.5.2.4 NMEA Filter (NMEA FILTER).....	44
2.5.2.5 Serial Port Monitor (SERIAL MON).....	45
2.5.2.6 Factory Reset (RESET).....	46
2.5.2.7 Log (LOG).....	47
2.5.2.8 NMEA Talker (NMEA TALKER).....	48
2.5.2.9 NMEA Settings (NMEA SET).....	49

3 Maintenance..... 50

4 Appendix A..... 51

4.1 Hardware Specifications.....	51
4.1.1 Specifications MFS-H.....	51
4.1.2 Specifications MFS-V.....	52
4.1.3 Specifications MFM.....	53
4.1.4 Product number.....	53
4.1.5 Available Accessories.....	54
4.2 Software Specifications.....	54
4.2.1 Supported NMEA Sentences IEC 61162.....	54
4.2.2 Indication List.....	54
4.3 Mechanical Drawings.....	55
4.3.1 Mechanical Drawing MFS-H.....	55
4.3.2 Mechanical Drawing MFM.....	56
4.4 Electric Diagrams.....	57
4.4.1 Cable diagram AlphaDepth.....	57
4.4.2 Connection Diagram AlphaDepth.....	58
4.5 Schematics.....	59
4.5.1 Schematics AlphaLine MF Display Unit.....	60
4.5.2 Schematics AlphaLine Instrument.....	61

I Preface

The Alpatron Marine AlphaLine instrument range was designed for navigation and control of ships and is based on generic hardware and software, allowing for many different applications.

- Thoroughly read this instruction manual before installation and operation of the equipment.
- We recommend to keep this manual nearby the equipment to ensure ready access to it.

I.1 Revision History

Revision No.	Software Version	Description	Date
V1.0	R1.015	First issue	17 June 2015
V1.0.1	R1.015	Textual changes	23 July 2015
V1.0.2	R1.015	Textual changes	01 September 2015
V1.0.3	R1.029	Textual changes	02 March 2016
V1.0.6	R1.035	Textual changes	16 December 2016
V1.0.8	R1.047	Textual changes	08 March 2019
V1.0.9	R1.047	Textual changes, new diagrams	10 June 2020

I.2 Glossary

The glossary contains a list of definitions and a list of abbreviations.

I.2.1 Definitions

The meaning of standard definitions as used in this manual are explained in *Table 1: Definitions* on page 4.

Redundant	A device that is equipped with multiple part of the same type, for example a double power supply. This equipment will continue to function when one of the redundant part fails.
Heading users	Navigation equipment that uses heading/course information for functioning.
Hardware	The physical parts of the AlphaLine instrument.
LED's	Light-emitting diodes. These are used for signaling statuses of hardware and software signals to the user.
Central alarm system / Bridge watch monitoring	System that is connected to all vital systems on a ship and that is able to give a centralized indication of the (alarm)status of all connected systems.
NMEA protocol	Protocol standard for transmitting and receiving of asynchronous serial data sentences.
Talker	Device which transmits data. This is usually called transmitter or TX.
Listener	Device which receives data. This is usually called receiver or RX.
ISO GND	Isolated Ground. This is a ground connection to be used for reference signal. It is different from EARTH and should normally not be connected to EARTH.
Grounding point/stud	Point on the chassis of the AlphaLine instrument which should be connected to the ship's mass.
Printed Circuit Board	A printed circuit board, or PCB, is used to mechanically support and electrically connect electronic components using conductive pathways, or traces, etched from copper sheets, laminated onto a non-conductive substrate.

(Galvanic) isolated	Electrical separation of two circuits. There is no current flowing directly from one circuit to another. Electrical energy and/or information can still be exchanged between the sections by other means, such as by induction or by optical means (like transformers or opto couplers).
CAN bus	Controller Area Network. This is a network based serial bus system used for exchanging information. It is the advanced version of RS485/422 serial buses.
Reverse polarity protection	This is a part of the power supply hardware that prevents any damage to the equipment when the power supply is connected to the wrong polarity.
ROT signal	Rate Of Turn (ROT) signal indicates the course change of a ship in degrees per minute. This signal can be analog using voltage or current, or can be an NMEA data signal.
Heading/bearing repeaters	Navigation type of instruments displaying the heading/course of a ship.
Baud rate	This is the transmission speed of serial interfaces in characters per second.
Transmitting interval	The frequency at which complete NMEA sentences are being transmitted in number of times per second.
Factory setting	Instrument setting for backlight color, language, number of connected apparatus, etc. as configured as a new instrument by the factory.
Flash memory	Non-volatile type of memory. This type of memory retains its contents even when the instrument is turned off.
Firmware	(Embedded) software inside the processors of the AlphaLine instrument.
Compass safe distance	The minimum distances to equipment that will not cause an unacceptable deviation of the ship's standard and steering compasses.

Table 1: Definitions

I.2.2 Abbreviations

Abbreviations as used in this manual are explained in *Table 2: Abbreviations* on page 5.

A	Ampere
ARD	AlphaLine Repeater Display
CAN	Controller Area Network
DC	Direct Current
DNV	Det Norske Veritas
ECDIS	Electronic Chart Display Information System
GPS	Global Positioning System
I/O	Inputs and Outputs
I.S.	Inter Switch
LED	Light-Emitting Diode
mA	Milliampere
mm	Millimeter
NC	Normally Closed
NMEA	National Marine Electronics Association
NO	Normally Open

OA	Operational Alarm
TAP	Type Approval Program
PCB	Printed Circuit Board
RCU	Remote Control Unit
ROT	Rate Of Turn
VAC	Volts Alternating Current
VDC	Volts Direct Current
VDR	Voyage Data Recorder
W	Watt

Table 2: Abbreviations

I.3 Norms and Standards

The AlphaDepth complies with the applicable standards, norms and regulations:

- IEC 60945 (2002) including IEC 60945 Corrigendum 1 (2008)
- Standard DNV 2.4
- IEC 61162 series
- IEC 62288 (2014)

II Safety Information

II.1 Pictorial Indication



- **DANGER**
- Indicates a hazardous situation which, if not avoided, will result in death or serious injury. This signal word is limited to the most extreme situations.



- **WARNING**
- Indicates a hazardous situation which, if not avoided, could result in death or serious injury.



- **CAUTION**
- Indicates a hazardous situation which, if not avoided, could result in minor or moderate injury.



- **NOTICE**
- Indicates information considered important but not related to injury. It is typically used to prevent damage to equipment or property.

II.2 Cautions



- **CAUTION**
- Do not disassemble or modify the equipment. Failure to observe this instruction may cause a fire, electric shock, or equipment failure.



- **CAUTION**
- Do not insert or remove the power cord or operate switches with a wet hand. Otherwise, you may suffer an electrical shock.



- **CAUTION**
- Operate the equipment only at the power supply voltage of 24 VDC. Failure to observe this instruction can cause a fire, electric shock, or equipment failure.



- **CAUTION**
- Do not scratch, damage, modify, heat, pull, excessively bend, or heavily load the power supply cable. It may cause a fire, or electric shock.



- **CAUTION**
- Immediately turn off the power and disconnect the power supply cable if the equipment is generating any smoke or odor, or is overheated. Immediately inform your local service agent of the symptom to have it repaired. Prolonged equipment operation under such a condition can cause a fire or electric shock.



- **CAUTION**
- Do not place a vessel containing liquid on the equipment. It may cause a fire, electrical shock, or a failure to the equipment if knocked over.



- **CAUTION**
- When unplugging the instrument, be sure to remove the cord terminal correctly. If the cord is pulled, the cord may get damaged resulting in a fire or an electrical shock.

II.3 Notices



- **NOTICE**
- Any modification to this equipment without prior written permission from ALPHATRON MARINE B.V. will void the warranty.



- **NOTICE**
- Installation of this product shall only be done by a certified installation company approved by either ALPHATRON MARINE B.V. or by an official ALPHATRON MARINE distributor. Acting otherwise will void the warranty.

- **NOTICE**
 - This product must be installed in accordance with the installation methods described in this manual. Acting otherwise will void the warranty.
- **NOTICE**
 - This product contains no operator serviceable parts. Service and repair shall only be carried out by personnel trained and certified by ALPHATRON MARINE B.V.
- **NOTICE**
 - Do not allow the instrument to fall or immerse into water. The equipment can be damaged.
- **NOTICE**
 - If the instruments are not stored as described, it will void the warranty.
- **NOTICE**
 - When cleaning the surface, do not use any organic solvent such as thinner or benzine. Otherwise, the paint and markings on the surface may get damaged. For cleaning the surface, remove the dust and debris and wipe with a clean dry cloth.

II.4 Warranty

Non-compliance with the installation, operation and maintenance requirements may void the warranty. Read *Safety Information* on page 7.

Contact the Alphatron Marine dealer regarding the terms of the warranty.

II.5 Storage

The AlphaLine range of instruments are sensitive to humidity, temperature fluctuations and aggressive substances. Store them appropriately.

- **NOTICE**
 - If the instruments are not stored as described, it will void the warranty.



III Introduction

Each type in this navigation and control instrument product range consists of a display unit and, if applicable, one or more external remote I/O modules.

The following display sizes are available for your AlphaLine instrument:

AlphaLine MFS-H	5.0 inch display	LCD orientation horizontal
AlphaLine MFM	6.5 inch display	LCD orientation vertical

The AlphaDepth shows the depth from any IEC 61121-1 compatible depth sensor. Features include shallow depth alarm, and selectable depth scales and units.

1 Installation Instructions

Installation follows a generic method and is applicable to the complete range of AlphaLine instruments. This chapter describes the installation into a console.

1.1 Mechanical Installation



- **NOTICE**

- This product must be installed in accordance with the installation methods described in this manual. Acting otherwise will void the warranty.

The Location Class/Category of the AlphaLine instrument is: EXPOSED (may be used outside), but only if installed with the optional sealing kit and according the installation instructions as mentioned in *Mounting Instrument* on page 10.

1.1.1 Supplied Parts

The AlphaDepth is supplied complete with the following parts:

- Display unit
- Mounting frame with 2 sets of screws for fixing to either steel or wood
- 3 x Phoenix connectors for power supply and signals
- USB stick with manual
- Mounting template
- Grounding lug

1.1.2 Dimensions

Carefully check the applicable drawing(s) of the instrument. See *Mechanical Drawings* on page 55.

1.1.3 Mounting Instrument

The display unit can only be flush mounted. Carefully consider the location and angle of the display unit for maximum visibility. Make sure that there is enough space to connect cables. The display unit can be installed horizontally, vertically or under an angle, see *Figure 1: Flush mounting* on page 10.



Note For outdoor fitting, use appropriate sealing arrangement.

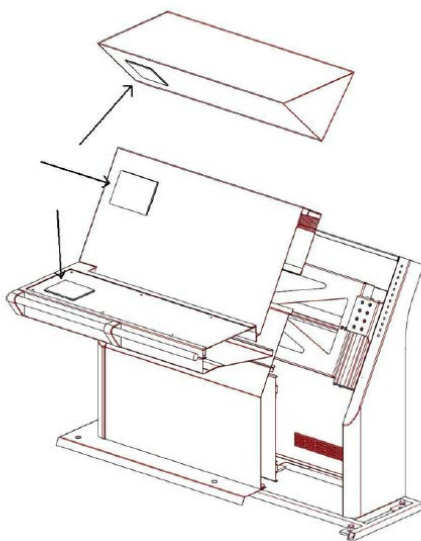

Figure 1: Flush mounting

1.1.4 Fitting Instrument Mounting Frame

Prior to fitting the display unit, install the mounting frame.



Figure 2: Mounting Frame MFS

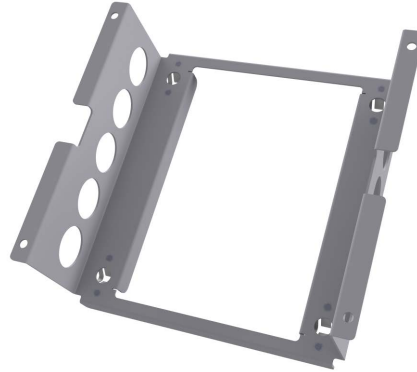

Figure 3: Mounting Frame MFM

1. Make a square hole in the (overhead) console. Use the provided template. For dimensions, see *Mechanical Drawing MFS-H* on page 55 or *Mechanical Drawing MFM* on page 56.
2. Push the mounting frame into the hole and attach it with four screws.
3. Push the display unit into the mounting frame.



Note The instrument is locked into position by a spring system.



Note Use the Overhead Mounting Kit for securing the display unit to an overhead console, to prevent the unit from falling out.

1.1.5 Fitting Instrument Water Seal

The instrument can be positioned outside, using a water seal. To apply the water seal, use the IP56 Kit and follow the mounting instructions below.

The IP56 Kit for AlphaLine MF consists of the following items:

- 1 dedicated gasket
- 4 adapters M3-M6
- 4 lock washers M6
- 4 hex nuts M6

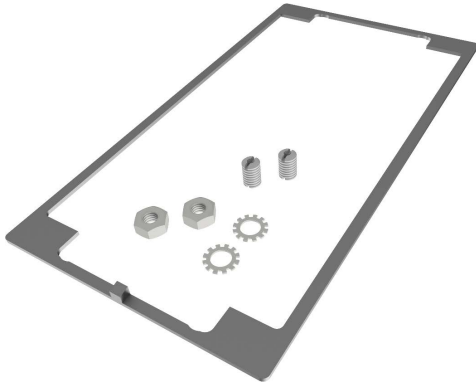

Figure 4: IP56 Kit for MFS

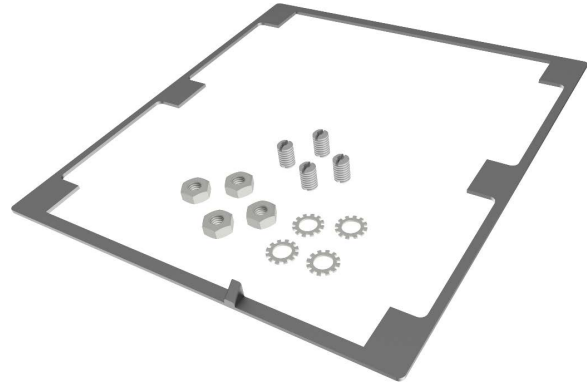





Figure 5: IP56 Kit for MFM

Mounting instructions:

1. Remove the 2 snaps (MFS) or 4 snaps (MFM) () from the instrument.
2. Add the 2 adapters M3-M6 (MFS) or 4 adapters M3-M6 (MFM) () to the instrument.
3. Remove the 2 clips (MFS) or 4 clips (MFM) () from the bracket.
4. Apply the gasket to the instrument.
INFO: Pay special attention to the small protruding cam, so that it fits exactly in the gap in the front panel.
5. Place the instrument in the bracket.
6. Mount the 2 lock washers and hex nuts (MFS) or 4 lock washers and hex nuts (MFM).

1.1.6 Instrument Electric Connections

All AlphaLine instrument versions share the same electronics with identical connections.

For pin-outs, see *Table 4: Serial Connector P12 (8 pins)* on page 17 and *Table 5: Serial Connector P19 (12 pins)* on page 17.

1.1.7 Cable

Use the following connection cables:

Name	Specification	Shield (Y/N)	Norm
Power	2 x 1.5 mm ²	Y	IEC 60092-352
USB	USB	Y	
Serial	3 x 2 x 0.5 mm ² (inside cabinets) 3 x 2 x 0.75 mm ² (ship's cabling)	Y	IEC 61162-2
Serial	2 x 2 x 0.5 mm ² (inside cabinets) 2 x 2 x 0.75 mm ² (ship's cabling)	Y	IEC 61162-1
Ethernet	Ethernet CAT 5e S/FTP	Y	

Table 3: Connection Cables

1.1.8 Cable Preparation

Cable preparation and cable connections as described in this manual are essential for the correct functioning of the instrument.



Note There are two type of cable sides (connections): sending cable sides and receiving cable sides. Normally, the cable shield will be grounded only at the sending side of the cable. For a power cable, this is the power supply side. For a data cable, this is the Tx side of the cable. For combined Tx/Rx cables, either side can be grounded, but beware of grounding only one side.

1.1.8.1 Cable Preparation Sending Sides

1. Remove approx. 80 mm of the plastic cable hose.
2. Cut away approx. half of the length of the now visible cable shield and fold the remaining shield back over the cable sheath.
3. Wrap insulating tape over half of the visible grounding shield.
4. Attach the remaining visible grounding shield to the metal saddle on the rear of the instrument. See *Figure 6: Cable Preparation Sending Cable Sides* on page 13.

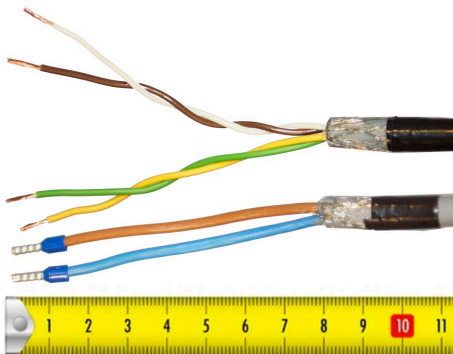

Figure 6: Cable Preparation Sending Cable Sides



Note Always check the drawing for the correct shielding of signals.

1.1.8.2 Cable Preparation Receiving Sides

1. Remove approx. 80 mm of the plastic cable hose, including the grounding shield.
2. Wrap insulating tape over the cable end.
3. Attach the isolated cable end to the metal saddle on the rear of the instrument. See *Figure 7: Cable Preparation Receiving Cable Sides* on page 14.

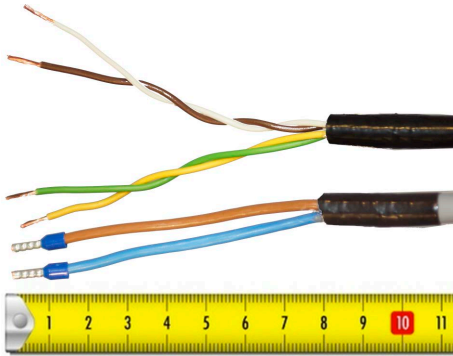

Figure 7: Cable Preparation Receiving Cable Sides

Note Always check the drawing for the correct shielding of signals.

1.1.9 Grounding Instrument

To function properly, the AlphaLine instrument must be grounded to the ship's mass.

For this purpose the instrument has a grounding bolt. Connect the grounding bolt to the ship's mass with a low impedance connection.

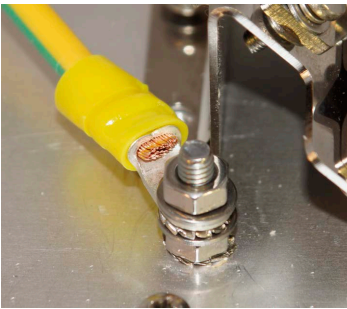

Figure 8: Grounding Bolt

Note The grounding strap must be as short as possible. If wire is used, use a minimum of 2.5 mm² copper wire. See *Figure 8: Grounding Bolt* on page 14.

Note Always check the drawing for the correct shielding of signals.

1.1.10 Instrument Power Supply

The AlphaLine instrument has one 24 VDC (nominal) power input. Power consumption is approx. 500 mA. Connect to a power supply > 1 A.

Note The power supply input is protected against connecting to the reversed polarity.

Note The rush current is approximately 4 A.

1.1.11 Serial Interfaces

This chapter provides extra information about the serial interfaces used in the Marine Electronics.

- IEC 61162-1

This standard is the most commonly used. In the standard, the sender (Tx side) and receiver (Rx side) are referred to as talker and listener.

It has the following characteristics:

- Communication speed: baud rate of 4800, 8 data bits, 1 stop bit, no parity.
- One talker (Tx side, commonly a sensor such as GPS) may be connected to one or more listeners (Rx side, e.g. displays or computer systems such as ECDIS). The circuit looks as shown in *Figure 9: IEC 61162-1 Circuits* on page 15.

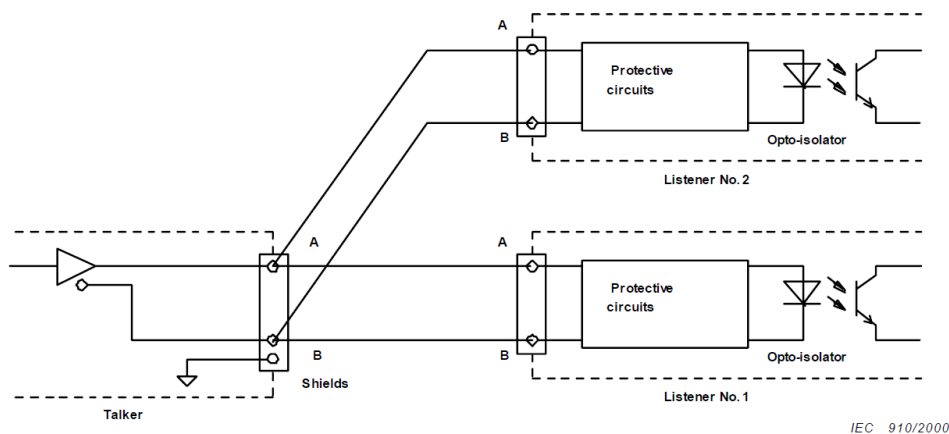

Figure 9: IEC 61162-1 Circuits

There are some requirements to the wiring of the signal.

- Tx+ and Tx- are connected to Rx+ and Rx- respectively.
- The shield of the cable is connected to earth on the transmitting side, and is NOT connected on the listener side.

Note In case the NMEA signal is connected both ways, two cables should be used with proper shielding as described above.

Only one talker is connected to the bus, and multiple listeners may be connected to the same bus without the need for a signal isolator/multiplier. However, it is accepted and good practice to use a multiplier since it eliminates possible faults caused by short circuiting of the signal by a faulty listener. Alphatron is able to supply such a multiplier if needed (NMEA Distribution Module MK2).

- IEC 61162-2

This standard is applied to provide better characteristics when the data transmission speed is higher.

It has the following characteristics:

- Communication speed: baud rate of 38400, 8 data bits, 1 stop bit, no parity.
- One talker (Tx side, commonly a sensor such as GPS) may be connected to one or more listeners (Rx side, e.g. displays or computer systems such as ECDIS). The circuit looks as shown in *Figure 10: IEC 61162-2 Circuits* on page 16.

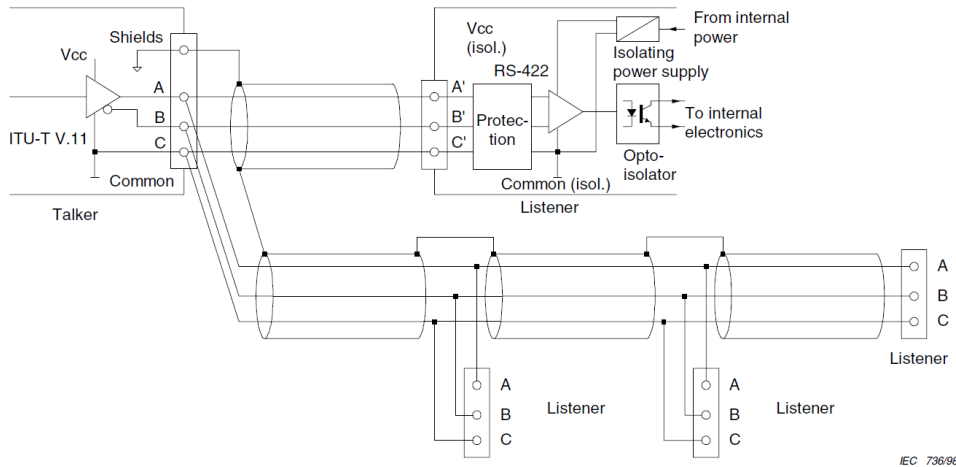

Figure 10: IEC 61162-2 Circuits

The main difference with the IEC 61162-1 standard is that a COMMON signal is added here for a good reference to isolated ground.

- Tx+ and Tx- are connected to Rx+ and Rx- respectively.
- The shield of the cable is connected to earth on the transmitting side, and is NOT connected on the listener side.

Note In case the NMEA signal is connected both ways, two cables should be used with proper shielding as described above.

Only one talker is connected to the bus, and multiple listeners may be connected to the same bus without the need for a signal isolator/multiplier. However, it is accepted and good practice to use a multiplier since it eliminates the possible faults caused by short circuiting of the signal by a faulty listener. Alpatron is able to supply such a multiplier if needed (NMEA Distribution Module MK2).

The cable should be of a shielded type, and the shield is connected to earth on the talker side and NOT to earth on the listener side.

The IEC 61162 specifies a number of different cables which can be used. Of these cables, Alpatron recommends to use single shielded cable, as shown in *Figure 11: Single Shielded Cable* on page 16.

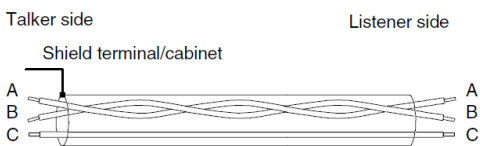

Figure 11: Single Shielded Cable

So, for a two way connection two times 3 wire cable is used with shield connected on the talker side.

Note For Modbus we recommend to use the IEC 61162-2 connections on equipment. IEC 61162-1 ports are also usable and tested to work with Modbus on speeds up to 38400 baud, however the IEC 61162-2 ports are here better suited because of the C wire for signal ground reference.

1.1.12 Serial Connection

The AlphaLine instrument has four IEC 61162 serial ports with Transmit (Tx) and Receive (Rx) connections. Three ports are of type IEC 61162-1, one port is of type IEC 61162-2.

The instrument has two serial connectors, connector P12 with 8 connections and connector P19 with 12 connections.

For pin connections, see *Figure 12: Serial pin connections* on page 17, *Table 4: Serial Connector P12 (8 pins)* on page 17 and *Table 5: Serial Connector P19 (12 pins)* on page 17.

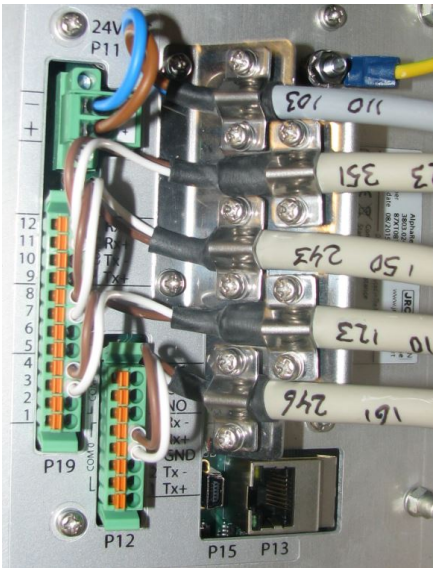

Figure 12: Serial pin connections

1	COM0	IEC 61162-2	Tx+
2	COM0	IEC 61162-2	Tx-
3	COM0	IEC 61162-2	GND
4	COM0	IEC 61162-2	Rx+
5	COM0	IEC 61162-2	Rx-

Table 4: Serial Connector P12 (8 pins)

1	COM1	IEC 61162-1	Tx+
2	COM1	IEC 61162-1	Tx-
3	COM1	IEC 61162-1	Rx+
4	COM1	IEC 61162-1	Rx-
5	COM2	IEC 61162-1	Tx+
6	COM2	IEC 61162-1	Tx-
7	COM2	IEC 61162-1	Rx+
8	COM2	IEC 61162-1	Rx-
9	COM3	IEC 61162-1	Tx+
10	COM3	IEC 61162-1	Tx-
11	COM3	IEC 61162-1	Rx+
12	COM3	IEC 61162-1	Rx-

Table 5: Serial Connector P19 (12 pins)



Note The instrument should always be connected according to the cable diagram. See *Electric Diagrams* on page 57. Ensure connection to the correct COM port.

1.1.13 Relay

One relay output is available for legacy alarm monitoring systems without serial ALR connection. This AlphaLine instrument relay output is located on the 8-pin connector on the following pins, for pin lay out, see *Table 6: Relay Connector P12 (8 pins)* on page 18. Use the NC (Normally Closed), or NO (Normally Open) connection depending on the application.

6	Relay	Normally Open
7	Relay	Common
8	Relay	Normally Closed

Table 6: Relay Connector P12 (8 pins)

1.1.14 Connecting Serial Ports

NMEA is the standard serial communication protocol for maritime sensors such as GPS, Speedlog and others. In the regulations is referred to the IEC standard for the correct protocol description. These are IEC 61162-1 and IEC 61162-2. The device will make use of both these standards as there is a difference between them.

For detailed information on both standards, please read the IEC 61162-1 and IEC 61161-2 regulations.

Serial Port	IEC Standard
COM 0	61162-2
COM 1	61162-1
COM 2	61162-1
COM 3	61162-1

Table 7: Serial Ports

To make connections: Connect the data signal to the COM port as shown in the *Electric Diagrams* on page 57.

1.1.15 Connecting Dimmer

AlphaLine instruments can accept IEC 61162-1 dimmer messages with the \$--DDC format.

Connect the signal to the designated dimmer connector as shown on the connection diagram, see *Electric Diagrams* on page 57.

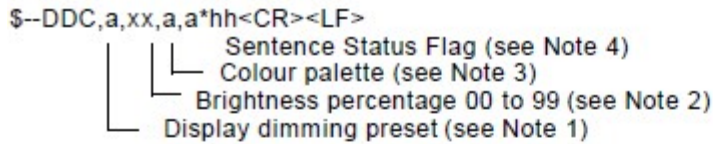

NOTE 1 The display dimming preset field contains an indicator that may be associated with a preset dimmed level on an electronic device.

D = Day time setting

K = Dusk setting

N = Night time setting

O = Backlighting off setting

Actual display brightness levels for the display dimming preset indicators above are dependant upon the capabilities provided by the manufacturer of the equipment. Proper use of this field would be as follows. A device provides the operator or user with the ability to set a brightness level to be associated with day, dusk night, etc. Upon receipt of the DDC sentence, the device would switch its display brightness to the preset value the operator had determined for the corresponding indicator value. If the equipment had no brightness or dimming preset capability this field would be ignored.

NOTE 2 The brightness percentage field contains a value from zero to ninety nine. The value zero, provided as 00, indicates that the display's brightness should be set to its most dimmed level, as determined by the capabilities of the equipment. The value ninety nine, provided as 99, indicates that the display brightness should be set to the brightest level, as determined by the capabilities of the equipment. Values between 0 and 99 correspond to some percentage of brightness, as determined by the equipment receiving this sentence.

NOTE 3 The colour palette preset field contains an indicator that may be associated with a preset dimmed level on an electronic device.

D = Day time setting

K = Dusk setting

N = Night time setting

O = Backlighting off setting

NOTE 4 This field is used to indicate a sentence that is a status report of current settings or a configuration command changing settings. This field should not be null.

R = Sentence is a status report of current settings (use for a reply to a query).

C = Sentence is a configuration command to change settings. A sentence without "C" is not a command.

Figure 13: Dimmer Message

1.2 Software Installation

The software version for this AlphaLine instrument is 1.x.

1.2.1 Selecting Active Software

The AlphaLine instrument is delivered with all software pre-installed. The commissioning engineer will select the function the AlphaLine instrument requires.

When a AlphaLine instrument is started up for the first time, or after a RESET, a selection menu appears where the required application can be selected. See *Figure 14: First Start up Screen (Empty)* on page 20.

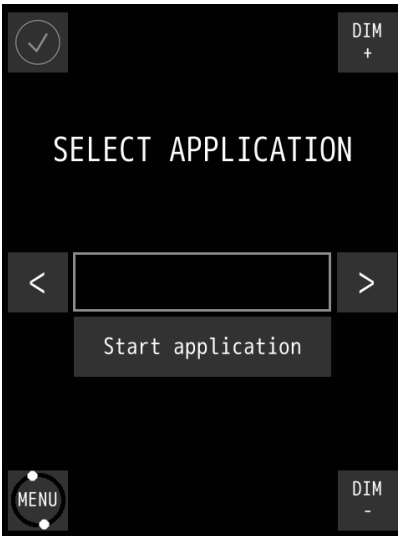

Figure 14: First Start up Screen (Empty)

1. Search for the required application by touching the < or > buttons.
2. Touch the Start application button once, the required application appears in the window. The AlphaLine instrument will restart itself, and install the selected application. This will take a couple of minutes to complete. Please be patient.

Note DO NOT switch off or disconnect the AlphaLine instrument while installing – this will corrupt the software and make the AlphaLine instrument inoperable.

Note After installation has been completed, the main screen of the application will appear.

1.2.1.1 Software applications

The selection menu shows the whole range of AlphaLine instruments applicable to this screen format and orientation, with the name of the software application displayed in the window. This name is different from the commercial name of the instrument. Below, you will find the correct software application name for the AlphaDepth.

Software application name	Commercial name instrument
Depth_5_LS_SEA	AlphaDepth

Table 8: MFS-H Software applications

Software application name	Commercial name instrument
Depth_6,5_PT_SEA	AlphaDepth

Table 9: MFM Software applications

1.2.2 Software Updates

Alphatron Marine is constantly improving and updating its products by developing new functionalities and improving usability and performance.

Visit our support website <https://www.jrc-world.com/en/support/> for the newest manuals and to check that your product is still running the latest software. Due to the nature of our products and solutions, software and relevant instructions will be available to authorized distributors and dealers only.

Software update files and procedures are made available by Alphatron and can be acquired from the Alphatron Service Desk at <https://www.jrc-world.com/en/support/>.



Note DO NOT shut down the device during an update procedure, because this can cause irreversible damage to the files on the internal storage device.

1.2.3 Watchdog Protection

AlphaLine display unit is guarded by a watchdog application. When the software freezes for an unknown reason, then after a pre-programmed period, the display unit will restart itself and ensures that the display unit is functional continuously.

Watchdog application is fed by a task with the highest priority in a multitask environment. See *Figure 15: Watchdog Application* on page 21. If one task freezes, the scheduler performs a context switch to other tasks with the same or higher priority. This way, the task with a lower priority will not be scheduled and the watchdog will not be fed. And finally, the watchdog will reset the processor.

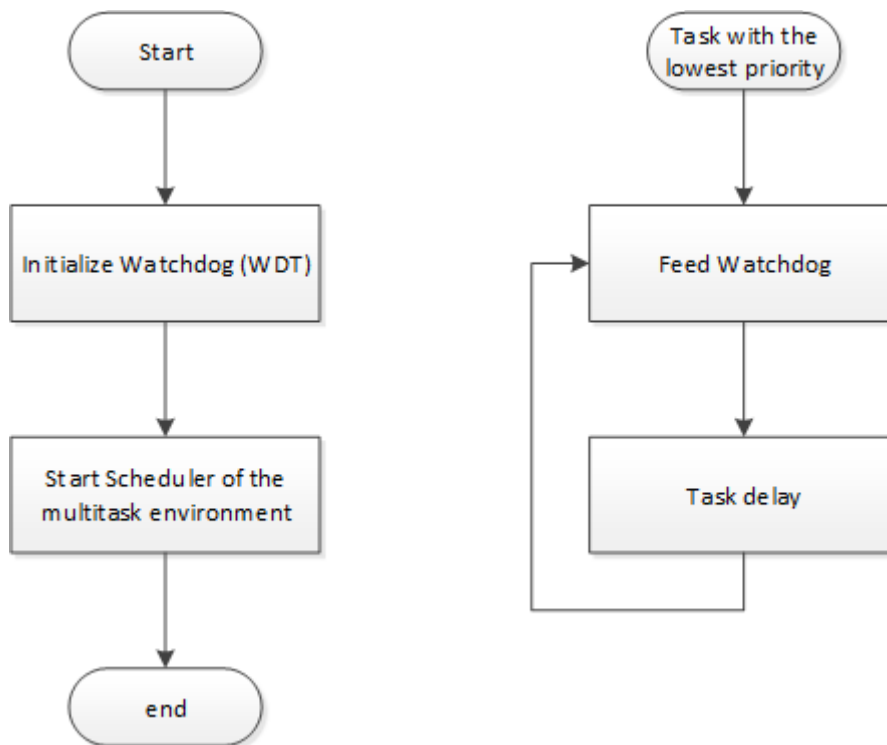



Figure 15: Watchdog Application

2 Operation

2.1 Power

The unit must be connected to the power at all times.

Use the power button in the front panel of the instrument to switch the power ON and OFF.

-  **Note** In the OFF position, the power button is still dimly lit for easy identification in the dark. This only applies when the instrument is connected to the power supply.
-  **Note** In a blackout situation, the instrument will always return to the last power state. This means that if the instrument was switched ON before a blackout, it will be ON after a blackout. The same applies to the OFF status. When the instrument is switched ON, the power button is lit in accordance with the DIM setting of the LCD backlight, so the power buttons dims together with the LCD panel.

2.2 Main Screen

When the AlphaLine Instrument is switched ON, it will boot into the AlphaLine Instrument application. The application will show the instrument specific data applicable to the particular instrument.

During the initialization time, while the instrument is starting up, the screen displays a startup screen, see *Figure 16: Splash Screen (example)* on page 22 . Depending on the display, the lower part of the screen shows the size of the instrument.

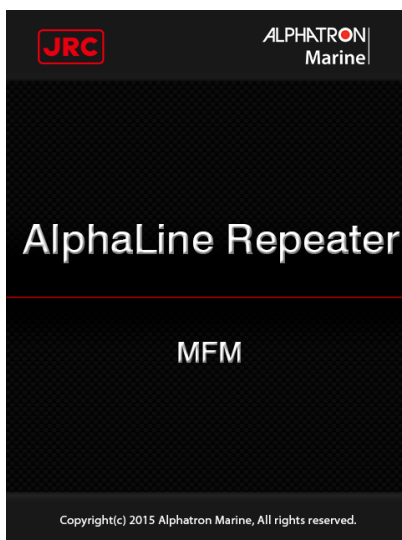

Figure 16: Splash Screen (example)

After the initialization time has been completed, the main screen appears. The main screen displays four standard buttons. See *Figure 17: Main Screen AlphaDepth* on page 23 and *Table 10: Main Screen Buttons* on page 23.



Figure 17: Main Screen AlphaDepth

Functionality of the buttons is as described in the following table.

	Shows the instrument is functioning normally. If there's a malfunction a colored alert symbol will show here. See <i>Table 13: Alert management icons</i> on page 29.
	Opens the MENU, where settings can be adjusted. This button also shows the functionality of the instrument by rotating. If it stops rotating, the software of the instrument is either very busy or it has crashed.
	Touching this button will set the LCD DIM level brighter.
	Touching this button will set the LCD DIM level one step less bright.

Table 10: Main Screen Buttons

2.3 Menu Handling

Menu handling is standardized for all different menu screens and for all different instruments. See *Figure 18: Menu Example* on page 24 for an example of the MENU and *Table 11: Explanation of On-screen Buttons and Icons* on page 24 for an explanation of the on-screen buttons and icons.



Figure 18: Menu Example

	Go to main screen. Touch again to go to MENU.
	Go back to the previous screen without saving settings.
	Undo the last value change.
	Accept and save current settings and applied settings will be saved.
	Undo all settings and exit MENU.
	Scroll between standard settings using the + or – button.
	Standard settings are divided into several screens. Navigate through these screens using the < or > button.

Table 11: Explanation of On-screen Buttons and Icons

2.3.1 Default Values AlphaLine Instrument

When the AlphaDepth is reset, it will return to the start-up screen, where a new instrument can be selected. The newly selected instrument will contain the default values.

The default values for the AlphaDepth are shown in the table below.

Menu → Theme		
	Theme	DAY
Menu → Date_Time [1/2]		
	Year	Compulsory Input
	Month	Compulsory Input
	Day	Compulsory Input
Menu → Date_Time [2/2]		
	Hour	Compulsory Input
	Minutes	Compulsory Input
	Time Zone	Compulsory Input
Menu → Range_Scale		
	SCALE	10
	ALARM	DISABLED
Menu → Units		
	DEPTH	metre
Menu → Offset		
	Offset	0.00
Menu → ADV_SET → CNTRL_DIM		
	INPUT	ANY
Menu → ADV_SET → Eth_Config		
	IP Address	192.168.31.31
	Subnet Mask	255.255.255.0
	Gateway	192.168.31.1
Menu → ADV_SET → UART Config [1/2]		
	UART	UART 0
	Parity	NONE
	Stop Bits	1
Menu → ADV_SET → UART Config [2/2]		
	Data Bits	8
	Baud Rate	4800
	Protocol	NMEA
Menu → ADV_SET → NMEA_FILTER		
	ID 1: Sentence	DPT

Menu → ADV_SET → NMEA_TALKER	
TALKER	**
USED / UNUSED	USED
Menu → ADV_SET → NMEA_SET	
SENTENCE	NONE
INTERVAL [ms]	1000
PORT	OFF

Table 12: Default Values for AlphaDepth

2.4 Indication Handling

If a malfunction occurs, an audible and visible alert will be activated. For alert handling while operating the main screen, see *Figure 19: Alert handling in Main screen (example)* on page 27

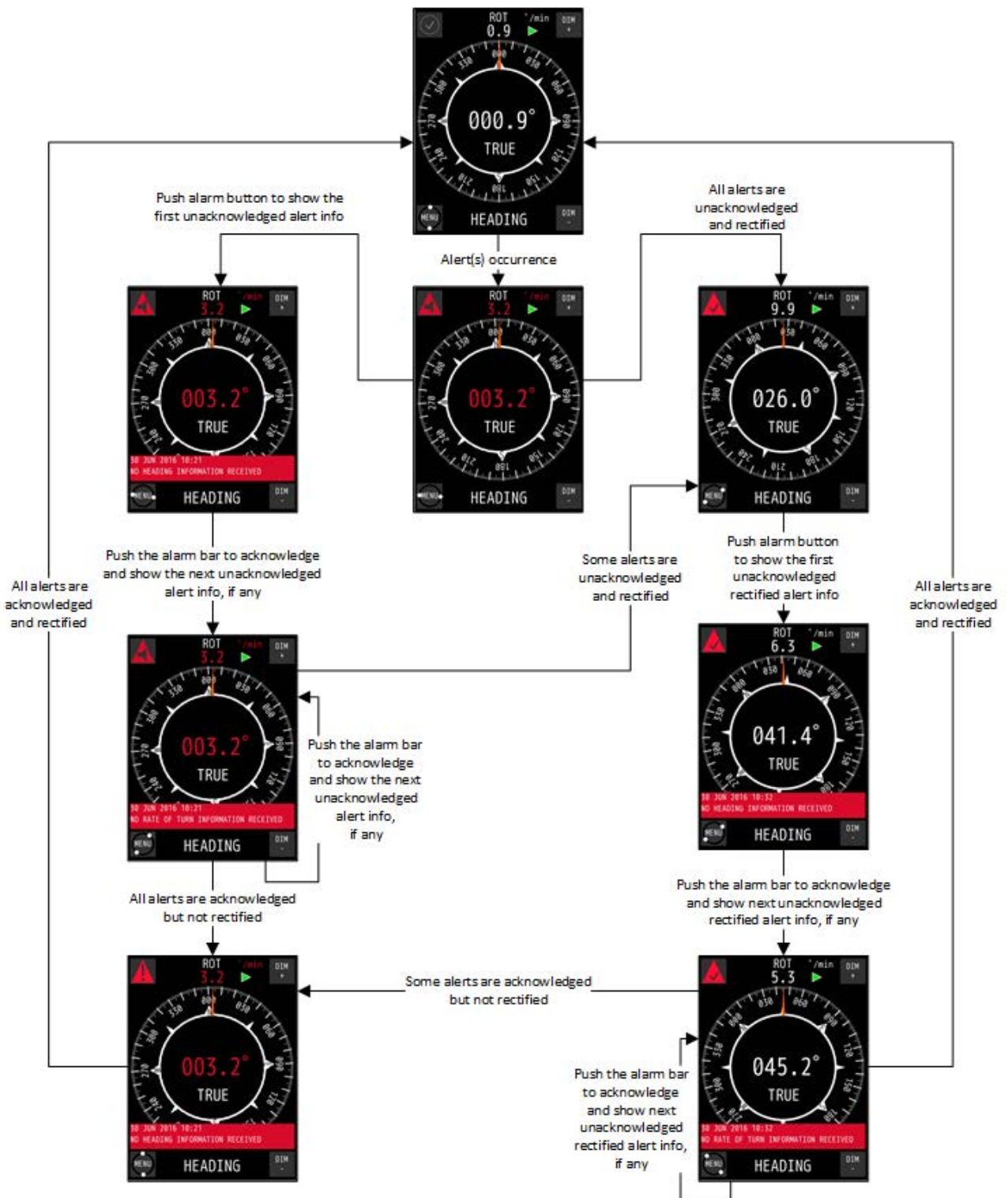

Figure 19: Alert handling in Main screen (example)

For alert handling while operating the MENU, see *Figure 20: Alert handling in menu (example)* on page 28

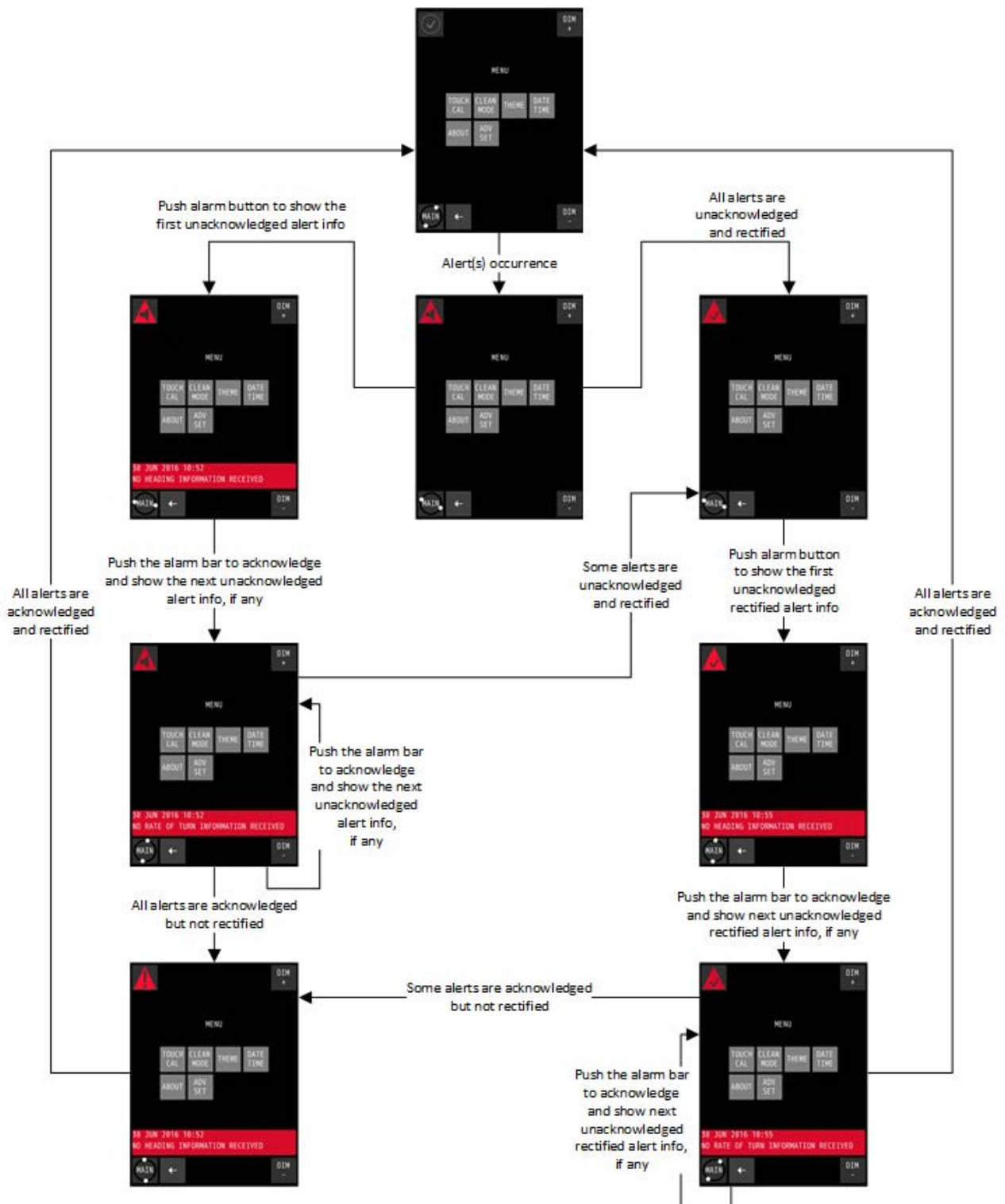

Figure 20: Alert handling in menu (example)





Number	Name	Description	Graphics
0	Normal condition	Stationary circle with gray tick mark	
1	Active - unacknowledged alarm	Flashing red triangle with loudspeaker and alert text. Touching this icon toggles the visibility of the alert text.	
2	Active - acknowledged alarm	Red triangle with exclamation mark and alert text. Touching this icon toggles the visibility of the alert text.	
3	Rectified - unacknowledged alarm	Flashing red triangle with tick mark and alert text. Touching this icon toggles the visibility of the alert text.	

Table 13: Alert management icons

2.5 Settings

All instruments have generic and advanced settings.

All users are authorized to use the generic settings. Only the commissioning engineer has access to the advanced settings, which are only needed during commissioning or troubleshooting.

2.5.1 Generic Settings Menu

Every user of the AlphaLine instrument can access the generic settings.

Touch the MENU button in the main screen to enter the MENU with generic settings, see *Figure 21: Generic Settings Menu* on page 30.

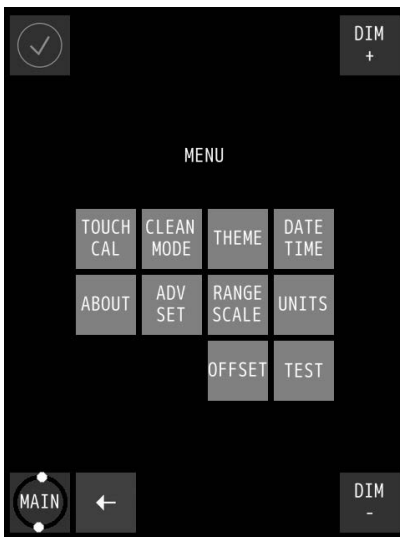

Figure 21: Generic Settings Menu

Select the button to configure a specific setting, or touch the ← button to return to the main screen.

2.5.1.1 Touch Screen Calibration (TOUCH CAL)

The touch screen can be calibrated by following the instructions that appear on the screen.



Figure 22: Touch Screen Calibration Menu

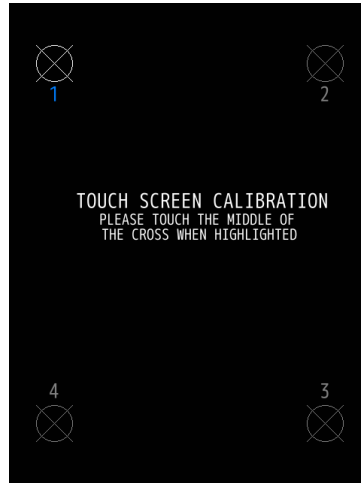

Figure 23: Calibration Reference Points



Figure 24: Calibration Lines

1. In the MENU, touch the TOUCH CAL button.
The TOUCH SCREEN CALIBRATION MENU appears, see *Figure 22: Touch Screen Calibration Menu* on page 31.
2. Calibrate the screen by touching the CONFIRM CALIBRATE THE TOUCH SCREEN button.
The calibration screen appears with text requesting to touch the four numbered reference points that appear on the screen, see *Figure 23: Calibration Reference Points* on page 31.
3. Touch the four reference points in sequence 1 to 4, as they light up.
The application will determine whether the sequence is carried out correctly.
4. If the text VALID CALIBRATION appears, then the calibration is performed accurately. Test calibration for accuracy by dragging a finger across the screen, see *Figure 24: Calibration Lines* on page 31.
The line that appears on the screen should follow the finger.
5. Touch the ACCEPT button if calibration appears to be correct, or touch the AGAIN button to repeat the calibration process.
6. If the text INVALID CALIBRATION...PLEASE RETRY appears, touch the AGAIN button to repeat the calibration process.

2.5.1.2 Cleaning Display (CLEAN MODE)

The purpose of CLEAN MODE is to clean the surface of the display unit without accidentally activating a function. When the CLEAN MODE is started, the touch screen will be deactivated for 60 seconds. Within this period the instrument will remain functional, but it is not operable. Except when an indication is activated, then the touch screen will be activated immediately and the instrument will be operable again.

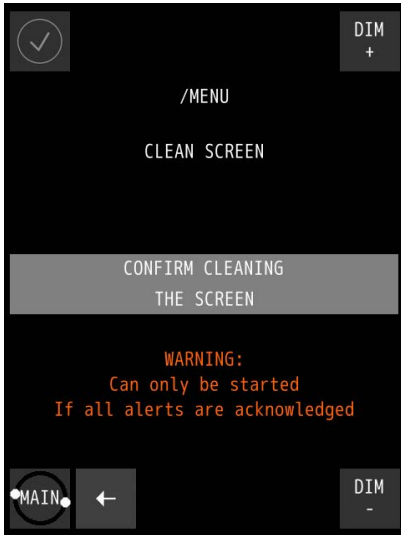

Figure 25: Clean Screen Menu

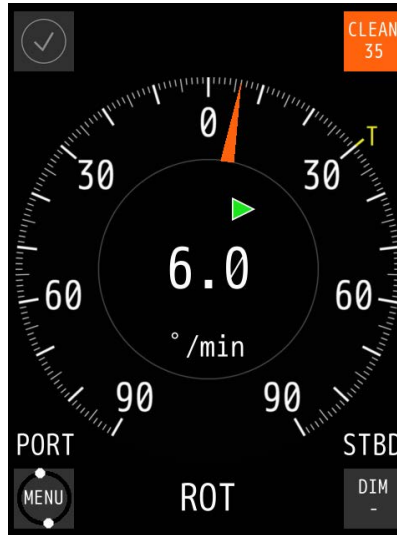

Figure 26: Clean mode Countdown (Example)

To start CLEAN MODE, perform the following actions:

1. In the MENU, touch the CLEAN MODE button.
The CLEAN SCREEN screen appears, see *Figure 25: Clean Screen Menu* on page 32.
2. Touch the CONFIRM CLEANING THE SCREEN button to start the CLEAN MODE.
The AlphaLine instrument switches to the CLEAN MODE COUNTDOWN page and starts the countdown sequence, see for example *Figure 26: Clean mode Countdown (Example)* on page 32.



Note For safety reason, if an alert is active and needs attention of the operator, CLEAN MODE can not be started.

The touch screen is now deactivated and surface can be cleaned. After 60 seconds, or at an active alert, the instrument will become operable again.

2.5.1.3 Change Theme (THEME)

2.5.1.3.1 Change Illumination

Contrast brightness can be easily adjusted to Day, Dusk and Night settings.

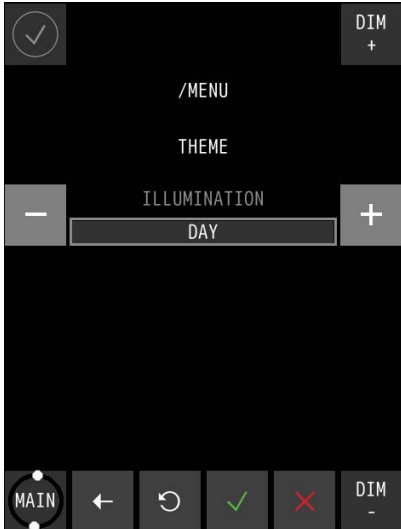

Figure 27: Theme Menu

1. In the MENU, touch the THEME button.
The THEME MENU appears, see *Figure 27: Theme Menu* on page 33 .
2. Touch the + or – buttons to select the desired ILLUMINATION value.

INFO: Three different ILLUMINATION presets can be selected, in accordance with ambient light; DAY, DUSK and NIGHT.

3. Touch the ✓ button to confirm the chosen setting.
The MENU appears again.

2.5.1.4 Change Date and Time (DATE/TIME)

The date and time can be adjusted.



Figure 28: Date/Time Screen 1

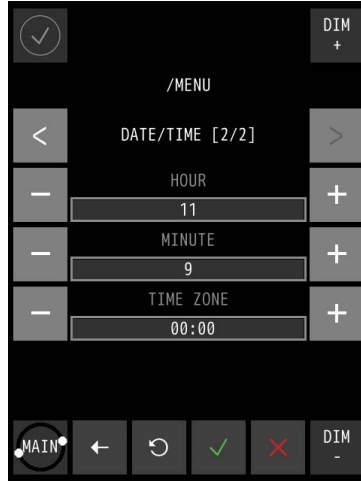

Figure 29: Date/Time Screen 2

1. In the MENU, touch the DATE/TIME button.
The DATE/TIME screen appears, see *Figure 28: Date/Time Screen 1* on page 34.
2. Touch the + and – buttons to set the correct DATE values.
3. Touch the > button to select the TIME screen, see *Figure 29: Date/Time Screen 2* on page 34.
4. Touch the + and – buttons to set the correct TIME values.
5. Touch the ✓ button to confirm the chosen values and return to the SETTINGS screen.
6. To abort, touch the ← button to return to the SETTINGS screen.

2.5.1.5 About the AlphaLine instrument (ABOUT)

The ABOUT screen contains the name and version of the software and when it was built.

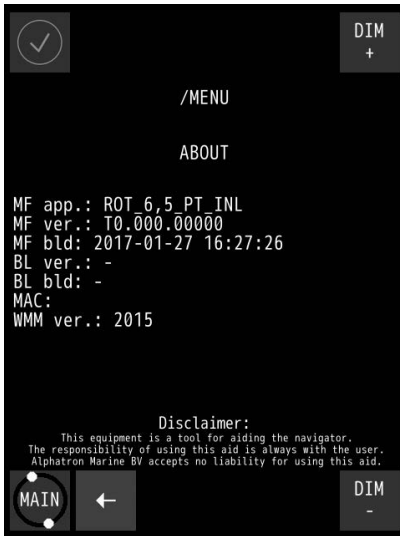



Figure 30: About the Alphaline Instrument (example)

1. In the MENU, touch the ABOUT button.
The ABOUT MENU appears, see for example *Figure 30: About the Alphaline Instrument (example)* on page 35.
 **Note** When asking for manufacturer's support, this information will be useful.
2. Touch the ← button to return to the SETTINGS screen.

2.5.1.6 Change Range Settings (RANGE SCALE)

The SCALE option allows to select a different graphical scale on the main display. This is practical for different uses, e.g. using a 10 m scale for shallow water, and a 100 m or 300 m scale on deeper water.

With the ALARM option, an alarm below a certain depth can be set. If the depth is less than the configured depth, an alarm will trigger (buzzer and visual indication).

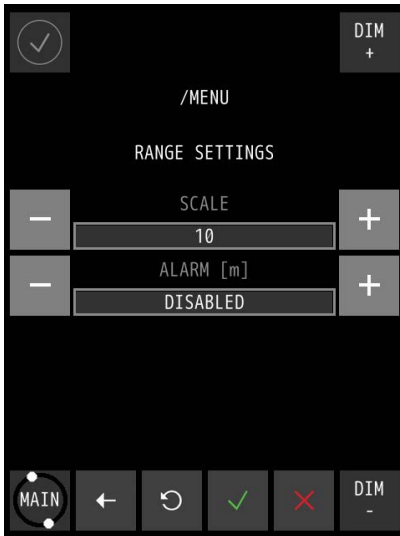

Figure 31: Range settings AlphaDepth

1. In the MENU, touch the RANGE SCALE button.
The RANGE SETTINGS MENU appears, see *Figure 31: Range settings AlphaDepth* on page 36
2. Repeatedly touch the + or – buttons to set the SCALE to 10, 100, 300 or DIGITAL.
3. Touch the + button to ENABLE the ALARM, repeatedly touch the + button to increase the value.
4. Set the precise number at which point the ALARM must be triggered, by repeatedly touching the + and – buttons.
5. Touch the ✓ button to confirm the chosen value.
The MENU appears again.

2.5.1.7 Unit Selection (UNITS)

The UNITS menu enables selection of unit to represent the displayed value.

UNITS of DEPTH can be selected in metre, feet and fathom. The default setting is metre.



Note A different UNIT selection does not automatically change the RANGE SCALE. It only changes the measurement units.



Figure 32: Units Menu AlphaDepth

1. In the MENU, touch the UNITS button.
The UNITS MENU appears, see *Figure 32: Units Menu AlphaDepth* on page 37.
2. Touch the + and – buttons to select the desired DEPTH units.
3. Touch the ✓ button to confirm the chosen settings.

2.5.1.8 Application Offset (OFFSET)

The purpose of KEEL OFFSET is to compensate the static error of the DEPTH sensor.

Besides that, it can also be used to convert the display values to show the Water Depth, or the Depth Below the Keel.

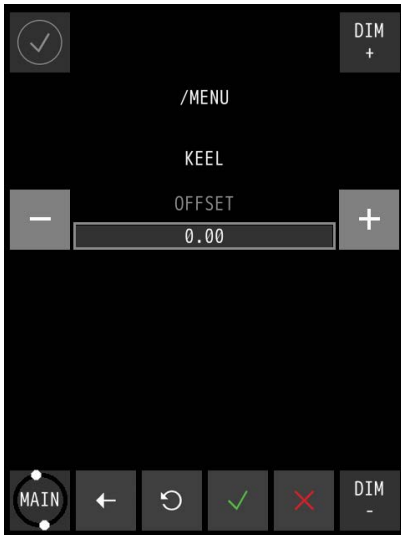

Figure 33: Keel OFFSET Menu

To set up the KEEL OFFSET settings, proceed as follows:

1. Touch the OFFSET button in the MENU.
The KEEL OFFSET menu appears, see *Figure 33: Keel OFFSET Menu* on page 38.
2. Touch the + and - buttons to set the correct OFFSET values.
3. Touch the ✓ button to confirm the chosen values and return to the SETTINGS screen.
4. Touch the ← button to abort and return to the SETTINGS screen.

2.5.1.9 Test Function (TEST)

The purpose of the TEST function is to let the user verify whether the alert handling is working correctly or not. After activating, the instrument will generate a dummy alarm and the user should experience the procedure which is described in paragraph *Indication Handling* on page 26.

To start the TEST function, perform the following actions:

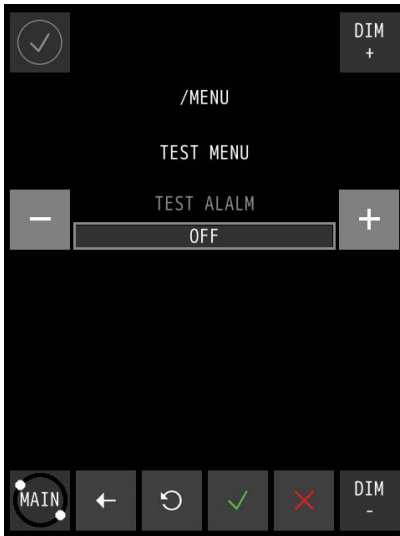

Figure 34: Test Menu

1. In the MENU, touch the TEST button.
The TEST MENU appears, see Figure *Test Menu*.
2. Touch the + or – buttons to select ON.
3. Touch the ✓ button to confirm the chosen setting.
The MENU appears again and the alarm is activated with a dummy alarm. Refer to paragraph *Indication Handling* on page 26 to review the different alert states.
4. Push alarm button to show the alarm bar.
The message “TEST ALARM IN PROGRESS” appears on the alarm bar.
5. Push the alarm bar to acknowledge the alarm.
The dummy alarm is acknowledged and stops flashing.
6. In the MENU, touch the TEST button again.
7. Touch the + or – buttons to select OFF.
8. Touch the ✓ button to confirm the chosen setting.
The instrument will return to the Normal Condition.

2.5.2 Advanced Settings Menu (ADV SET)

The Advanced Settings menu is password protected and is for use by commissioning engineers only.

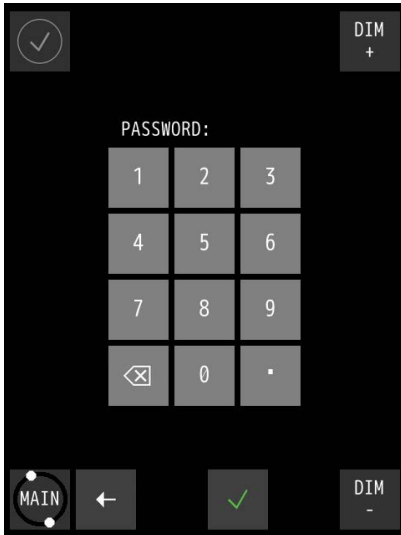

Figure 35: Password Screen

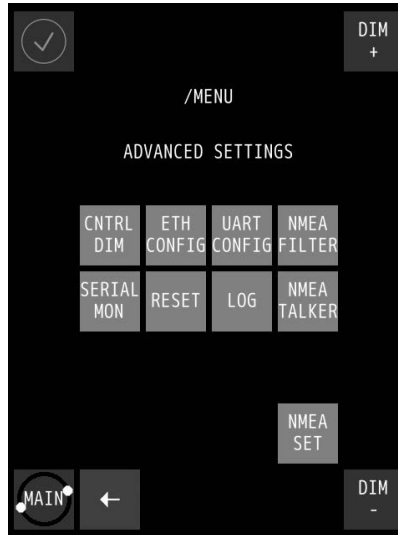

Figure 36: Advanced Settings Menu

1. In the MENU, touch the ADV SET button.
The PASSWORD screen appears, see *Figure 35: Password Screen* on page 40.
2. Key in the password and confirm with the ✓ button.
The ADVANCED SETTINGS MENU appears, see *Figure 36: Advanced Settings Menu* on page 40.
3. Select the button to configure a specific setting, or touch the ← button to return to the MENU.

2.5.2.1 Central Dimming (CNTRL DIM)

The AlphaLine instrument supports central dimming as a listener (slave) from a standard (IEC 61162-1) dimming sentence.

This dimming signal should be connected to serial port COM3, see *Table 5: Serial Connector P19 (12 pins)* on page 17. Also see *Figure 12: Serial pin connections* on page 17.

If a central dimmer is connected, it can be enabled through the CENTRAL DIMMER menu, see *Figure 37: CENTRAL DIMMER menu* on page 41.



Figure 37: CENTRAL DIMMER menu

1. In the ADVANCED SETTINGS menu, touch the CNTRL DIM button.
The CENTRAL DIMMER screen appears, see *Figure 37: CENTRAL DIMMER menu* on page 41.
2. Touch the + or – button next to INPUT to select ANY, NONE, ETHERNET, UART0, UART1, UART2, or UART3.
3. Touch the ✓ button to confirm the chosen setting.

2.5.2.2 Ethernet Configuration (ETH CONFIG)

The AlphaLine instrument has one network interface to connect to a ship's network.

This can be useful when the instrument is connected to a remote interface or a PLC which uses Modbus / TCP. The Ethernet interface can also be used for IEC 61162-450 signals.



Note This option has been included for future use.

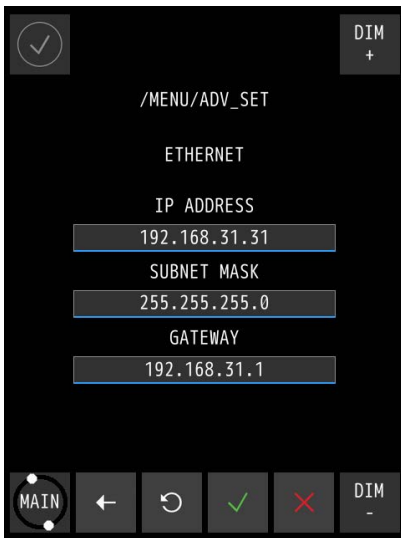

Figure 38: Ethernet Menu

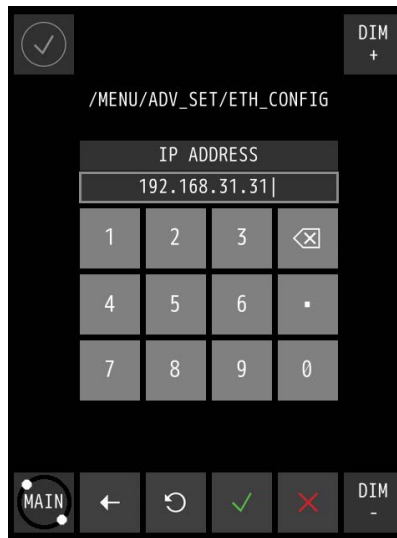

Figure 39: Numeric Pad

1. In the ADVANCED SETTINGS menu, touch the ETH CONFIG button.
The ETHERNET screen appears, see *Figure 38: Ethernet Menu* on page 42.
2. Touch the bar below IP ADDRESS, SUBNET MASK, or GATEWAY to change these.
The numeric pad appears every time one of the bars is touched, see *Figure 39: Numeric Pad* on page 42.
3. Touch the numbers to insert new numbers and touch the X button to delete numbers.
4. Touch the ✓ button when numbers are correct.
5. Touch the ✓ button again to confirm the IP ADDRESS, SUBNET MASK and GATEWAY settings.

2.5.2.3 Serial Port Configuration (UART CONFIG)

The AlphaLine instrument is equipped with 4 serial ports (also called UART or COM).

The settings of the serial ports are divided over two screens as shown in *Figure 40: UART Screen 1* on page 43 and *Figure 41: UART Screen 2* on page 43. Use the < or > button to toggle between the screens.

The default setting for NMEA (IEC 61162-1) data is 4800 baud, 8 data bits, 1 stopbit. The default setting for Modbus over serial port is 19200 baud, 8 data bits, 1 stop bit and EVEN parity. See also *Default Values AlphaLine Instrument* on page 25.

Select and configure NMEA when a sensor is connected with the standard NMEA signals. Select MODBUS MASTER when an interface (such as Analog Interface MK2 or AlphaTurn Interface MK2) is used.



Figure 40: UART Screen 1

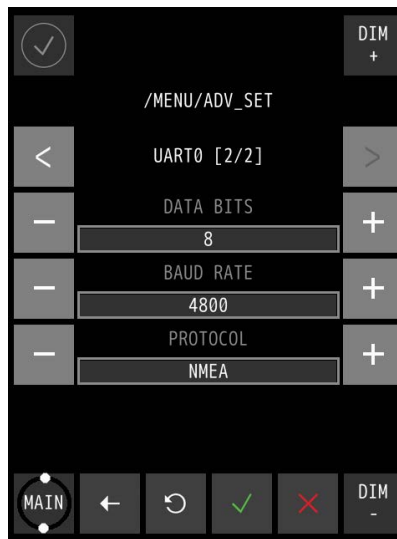

Figure 41: UART Screen 2

1. In the ADVANCED SETTINGS menu, touch the UART CONFIG button.
The UART screen 1 appears, see *Figure 40: UART Screen 1* on page 43.
2.
 - Touch the + or – button to set UART from 0 to 3.
 - Touch the + or – button to set PARITY to ODD, EVEN, FORCED 0, FORCED 1, NONE.
 - Touch the + or – button to set STOP BITS to 1 or 2.
3. Touch the > button to toggle to screen 2, see *Figure 41: UART Screen 2* on page 43 and follow the same principle as for screen 1. Touch the < button to return to screen 1.
4. Touch the ✓ button when the settings are correct.
5. If settings are modified, restart the instrument to initialize the serial port again.

2.5.2.4 NMEA Filter (NMEA FILTER)

This filter is included to select the correct sentence where several sentence options are possible for the same function.

There are 2 circumstances where such situation can occur:

1. A single sensor which produces different NMEA sentences with the same value.
2. If 2 sensors are connected, which produce different NMEA sentences with the same value.

This filter allows user to select one of the optional sentences to be used in the display.

During installation of the AlphaLine instrument, execute the following procedure to select the correct sentence for its intended use, see *Figure 42: NMEA Filter Menu (example)* on page 44.



Figure 42: NMEA Filter Menu (example)

1. In the ADVANCED SETTINGS menu, touch the NMEA FILTER button. The FILTER MENU appears.
2. Select FILTER ID depending on the type of sensor used by touching the < or > buttons.
3. Select the correct SENTENCE FILTER by touching the + or – buttons.
4. Touch the ✓ button to confirm.

2.5.2.5 Serial Port Monitor (SERIAL MON)

It is possible to show serial data transmitted and received over the serial ports.

Usually, NMEA signals should be viewed as ASCII data and Modbus data should be viewed as HEX data. Received data as well as sent data can be viewed (but not simultaneously). Select the appropriate button (Tx/Rx). For NMEA, Rx is normally used.



Figure 43: Serial Port 1



Figure 44: Serial Port 4

1. In the ADVANCED SETTINGS menu, touch the SERIAL MON button.
The SERIAL PORT MONITOR 1 screen appears, see *Figure 43: Serial Port 1* on page 45.
2. Touch the < or > buttons to select next port, see *Figure 44: Serial Port 4* on page 45.
3. Touch the Rx/Tx buttons to show the Received/Transmitted data.
4. Touch the ASCII/HEX buttons to show the characters in ASCII code or in HEX values.
5. Touch the ← button to return to ADVANCED SETTINGS MENU.



Note All serial ports are configured with the same procedure, the Serial Port screen has the following options:

- Baud rate: - Baud rate is a setting for Modbus devices, NMEA talkers, and other devices. It is a derived value based on the number of symbols transmitted per second. Valid values are: 1200, 2400, 4800, 9600, 19200, 38400, 57600 or 115200. The default value for NMEA is 4800 (Bd). The default value for Modbus communication is 19200 (Bd).
- Data bits: - The numbers of data bits in each character can be 7 (for true ASCII), 8 (for any kind of data, as this matches the size of a byte). 8 Data bits are almost universally used in newer applications. 7 Bits is only used on special occasions. Valid values are: 7 or 8. The default value for NMEA and Modbus communication is 8.
- Stop bits: - Stop bits sent at the end of every character allow the receiving signal hardware to detect the end of a character and to resynchronize with the character stream. Electronic devices usually use one stop bit. Valid values are: 1 or 2. The default value for NMEA and Modbus communication is 1.
- Parity: - Parity is a method of detecting errors in transmission. When parity is used with a serial port, an extra data bit is sent with each data character, arranged so that the number of '1' bits in each character, including the parity bit, is always ODD or always EVEN. If a byte is received with the wrong number of '1's, then it must have been corrupted. However, an EVEN number of errors can pass the parity check. Valid values are: N (None), O (Odd) or E (Even). The default value for NMEA is N (None). The default value for Modbus communication is E (Even).

2.5.2.6 Factory Reset (RESET)

All menu settings can be reset to the factory default setting. For an overview of the default settings, see *Default Values AlphaLine Instrument* on page 25.



Figure 45: Execute Factory Reset

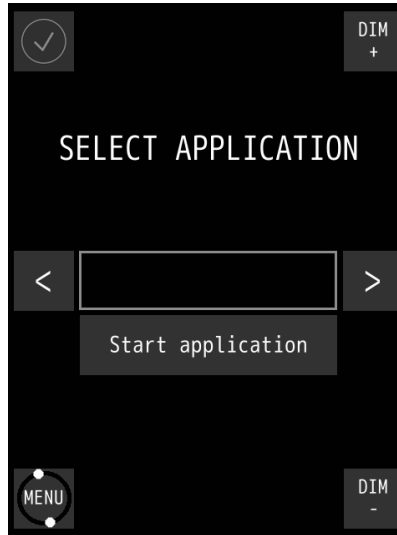

Figure 46: First Start-Up Screen

1. In the ADVANCED SETTINGS menu, touch the RESET button.
The EXECUTE FACTORY RESET screen appears, see *Figure 45: Execute Factory Reset* on page 46.
2. Touch the CONFIRM RESET ALL SETTINGS TO FACTORY DEFAULTS button for a full reset to factory default values.
The AlphaLine instrument reverts to the first start-up screen, see *Figure 46: First Start-Up Screen* on page 46.
3. To return to the previous menu screen, touch the ← button.

2.5.2.7 Log (LOG)

The log screen shows information useful for fault finding.

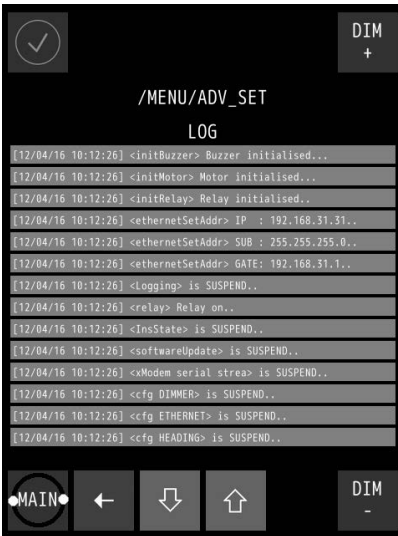

Figure 47: Log Screen

1. In the ADVANCED SETTINGS menu, touch the LOG button.
The log screen appears, see *Figure 47: Log Screen* on page 47.
2. Touch the ↓ or ↑ buttons to scroll through the readings.
3. Take a picture of the log screen and contact the Alpatron Service Desk at <https://www.jrc-world.com/en/support/> about errors.

Note Use for example a mobile phone to take a picture.

4. Touch the ← button return to the ADVANCED SETTINGS MENU.

INFO: Touching the MAIN button takes you back to the main screen.

2.5.2.8 NMEA Talker (NMEA TALKER)

With this menu, some additional NMEA sentence filters can be applied on the address field of an NMEA sentence. The address field consists of a talker ID and a sentence formatter (for example ROT). This is depending on the configuration of the software.

- TALKER - This item is prepared for future expansion, it is now set to **, which means that the NMEA (IEC 61162-1) Talker ID is not checked. Any talker ID is always accepted with the selected sentence formatter.
- USED/UNUSED - This setting defines the acceptance of the sentence based on the combination of the selected Talker ID and selected sentence formatter. If this is set to UNUSED all sentences formatted with the selected Talker ID are ignored. For now, this makes it possible for example to reject some specific sentence formatter.



Figure 48: NMEA Talker Menu

1. In the ADVANCED SETTINGS menu, touch the NMEA TALKER button.
2. Select the correct sentence formatter by touching the < or > buttons.
INFO: The TALKER is ignored, thus it is indicated as a "Wild card" by **.
3. Touch the + or – buttons to switch selection between USED and UNUSED.
4. Touch the ✓ button to confirm.

2.5.2.9 NMEA Settings (NMEA SET)

The AlphaLine instrument is able to transmit NMEA sentence to the external listener.

In this software version, it only supports the sentence VBW and DDC.

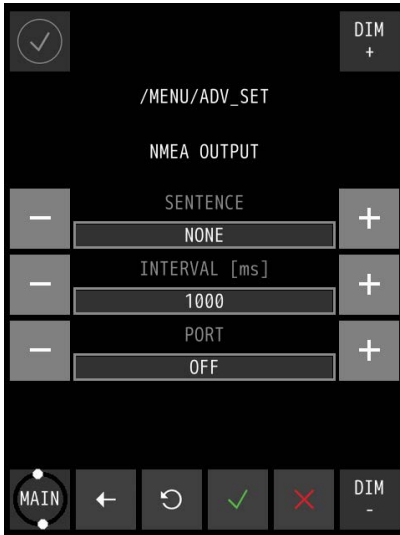

Figure 49: NMEA OUTPUT

To set up the output settings, execute the following procedure:

1. In the ADVANCED SETTINGS menu, touch the NMEA SET button.
The NMEA OUTPUT MENU appears, see *Figure 49: NMEA OUTPUT* on page 49
 2.
 - Touch the + or - button to set SENTENCE to VBW, DDC or NONE.
 - Touch the + or - button to set INTERVAL to 100, 250, 500, 1000, 2000 (ms) or BY CHANGE.

Note BY CHANGE means after each change of the value, the new value will be transmitted.
 - Touch the + or - button to set PORT to OFF, MULTI, UART0, UART1, UART2, UART3 or TCP.
 3. Touch the ✓ button when the settings are correct.
- Note** Please refer to *Supported NMEA Sentences IEC 61162* on page 54 for more details about the supported sentences.

3 Maintenance

- **NOTICE**
 - This product does not require any maintenance. Service and repair shall only be carried out by personnel trained and certified by ALPHATRON MARINE B.V.
- **NOTICE**
 - When cleaning the surface, do not use any organic solvent such as thinner or benzine. Otherwise, the paint and markings on the surface may get damaged. For cleaning the surface, remove the dust and debris and wipe with a clean dry cloth.

4 Appendix A

Appendix A contains:

1. *Hardware Specifications* on page 51
2. *Mechanical Drawings* on page 55
3. *Electric Diagrams* on page 57
4. *Schematics* on page 59

4.1 Hardware Specifications

4.1.1 Specifications MFS-H

Box Contents upon Delivery	
AlphaLine MFS-H	
Mounting bracket	
Screws (2 pcs)	
USB flash drive with manuals	
Template for cut-outs	
Sheet with front stickers	

Physical Dimensions	
Dimensions (WxHxD)	180x96x72 mm (7.09x3.78x2.83")
Panel cut-out (WxH)	160x90 mm (6.23x3.54")
Weight	0.754 kg (1.66 lbs)

Power Specifications	
Power supply	24 VDC input +/- 20% (Single source)
Power consumption	12 W (24 VDC @ 500 mA inrush prox. 4 A)
Protection	Reverse polarity protection
Start-up time	30 sec.

Operating Conditions	
Operating temperature	-25°C to +55°C ¹
Operating humidity	Up to 95% (at 40°C)
Storage temperature	-25°C to +70°C
Storage humidity	Up to 95% (at 40°C)
IP rating	IP56 front / IP22 back
Compass safe distance	Std: 0.1m / Steering: 0.1m

Environmental according to DNV 2.4 table 2.1	
Temperature	Class D
Humidity	Class B
Vibration	Class A
EMC compatibility	Class B
Enclosure	Class C

Display Functionality	
Font display text	7 mm (viewing distance = 2 m)
Font operation buttons	3.5 mm (viewing distance = 1 m)
Accuracy	Resolution 0.1"/min
Acoustic noise level	0 db

Display Specifications	
High quality TFT	Touch screen 5"
Pixels	800 x 480 (aspect ratio 5:3)
Orientation	Horizontal
Light intensity	Max. brightness 450 cd/m2
View angle (H/V)	140°/180°
Maximum colors	16.7 million

Input/Output Signals	
COM 0 (IEC 61162-2) isolated	Modbus RTU Rx/Tx
COM 1 (IEC 61162-1) isolated	NMEA Rx/Tx
COM 2 (IEC 61162-1) isolated	NMEA Rx/Tx
COM 3 (IEC 61162-1) isolated	NMEA Rx/Tx
USB port (Mini)	Used for software update/maintenance
Alarm output	NO/NC contact (potential free)

Norms/Standards	
IEC 60945 (2002)	Incl. IEC 60945 Corrigendum 1 (2008)
Standard DNV 2.4	Environment test
IEC 61162 series	NMEA Definitions
IEC 62288 (2014)	Display presentation

4.1.2 Specifications MFS-V

Box Contents upon Delivery	
Mounting bracket	
Screws (2 pcs)	
USB flash drive with manuals	
Template for cut-outs	
Sheet with front stickers	

Physical Dimensions	
Dimensions (WxHxD)	96x180x80 mm (3.78x7.09x3.15")
Panel cut-out (WxH)	90x160 mm (3.54x6.23")
Weight	0.754 kg (1.66 lbs)

Power Specifications	
Power supply	24 VDC input +/- 20% (Single source)
Power consumption	12 W (24 VDC @ 500 mA inrush prox. 4 A)
Protection	Reverse polarity protection
Start-up time	30 sec.

Operating Conditions	
Operating temperature	-25°C to +55°C ²
Operating humidity	Up to 95% (at 40°C)
Storage temperature	-25°C to +70°C
Storage humidity	Up to 95% (at 40°C)
IP rating	IP56 front / IP22 back
Compass safe distance	Std: 0.1m / Steering: 0.1m

Environmental according to DNV 2.4 table 2.1	
Temperature	Class D
Humidity	Class B
Vibration	Class A
EMC compatibility	Class B
Enclosure	Class C

Display Functionality	
Font display text	7 mm (viewing distance = 2 m)
Font operation buttons	3.5 mm (viewing distance = 1 m)
Accuracy	Resolution 0.1°/min
Acoustic noise level	0 db

Display Specifications	
High quality TFT	Touch screen 5"
Pixels	480 x 800 (aspect ratio 3:5)
Orientation	Vertical
Light intensity	Max. brightness 450 cd/m2
View angle (H/V)	140°/180°
Maximum colors	16.7 million

Input/Output Signals	
COM 0 (IEC 61162-2) isolated	Modbus RTU Rx/Tx
COM 1 (IEC 61162-1) isolated	NMEA Rx/Tx
COM 2 (IEC 61162-1) isolated	NMEA Rx/Tx
COM 3 (IEC 61162-1) isolated	NMEA Rx/Tx
USB port (Mini)	Used for software update/maintenance
Alarm output	NO/NC contact (potential free)

Norms/Standards	
IEC 60945 (2002)	Incl. IEC 60945 Corrigendum 1 (2008)
Standard DNV 2.4	Environment test
IEC 61162 series	NMEA Definitions
IEC 62288 (2014)	Display presentation

¹ Although the test conditions for bridge units provide for a maximum operation temperature of 55°C, continuous operation of all electronic components should, if possible, take place at ambient temperature of 25°C. This is necessary for a long life and low service costs.

² Although the test conditions for bridge units provide for a maximum operation temperature of 55°C, continuous operation of all electronic components should, if possible, take place at ambient temperature of 25°C. This is necessary for a long life and low service costs.

4.1.3 Specifications MFM

Box Contents upon Delivery	
AlphaLine MFM	
Mounting bracket	
Screws (4 pcs)	
USB flash drive with manuals	
Template for cut-outs	
Sheet with front stickers	

Physical Dimensions	
Dimensions (WxHxD)	160x180x80 mm (6.30x7.09x3.15")
Panel cut-out (WxH)	138x172 mm (4.84x6.77")
Weight	1.23 kg (2.71 lbs)

Power Specifications	
Power supply	24 VDC input +/- 20% (Single source)
Power consumption	12 W (24 VDC @ 500 mA inrush prox. 4 A)
Protection	Reverse polarity protection
Start-up time	30 sec.

Operating Conditions	
Operating temperature	-25°C to +55°C ³
Operating humidity	Up to 95% (at 40°C)
Storage temperature	-25°C to +70°C
Storage humidity	Up to 95% (at 40°C)
IP rating	IP56 front / IP22 back
Compass safe distance	Std: 0.1m / Steering: 0.1m

Environmental according to DNV 2.4 table 2.1	
Temperature	Class D
Humidity	Class B
Vibration	Class A
EMC compatibility	Class B
Enclosure	Class C

Display Functionality	
Font display text	7 mm (viewing distance = 2 m)
Font operation buttons	3.5 mm (viewing distance = 1 m)
Accuracy	Resolution 0.1°/min
Acoustic noise level	0 db

Display Specifications	
High quality TFT	Touch screen 6.5"
Pixels	480 x 640 (aspect ratio 3:4)
Orientation	Vertical
Light intensity	Max. brightness 450 cd/m2
View angle (H/V)	140°/160°
Maximum colors	16.7 million

Input/Output Signals	
COM 0 (IEC 61162-2) isolated	Modbus RTU Rx/Tx
COM 1 (IEC 61162-1) isolated	NMEA Rx/Tx
COM 2 (IEC 61162-1) isolated	NMEA Rx/Tx
COM 3 (IEC 61162-1) isolated	NMEA Rx/Tx
USB port (Mini)	Used for software update/maintenance
Indication output	NO/NC contact (potential free)

Norms/Standards	
IEC 60945 (2002)	Incl. IEC 60945 Corrigendum 1 (2008)
Standard DNV 2.4	Environment test
IEC 61162 series	NMEA Definitions
IEC 62288 (2014)	Display presentation

4.1.4 Product number

Product name	Product number	Original number
AlphaLine MFS-H grey	G-002741	3803.0226
AlphaLine MFS-H black	G-002742	3803.0228
AlphaLine MFS-V grey	G-002743	3105.0092
AlphaLine MFS-V black	G-002744	3105.0094

³ Although the test conditions for bridge units provide for a maximum operation temperature of 55°C, continuous operation of all electronic components should, if possible, take place at ambient temperature of 25°C. This is necessary for a long life and low service costs.



Product name	Product number	Original number
Alphaline MFM grey	G-002749	3803.0242
Alphaline MFM black	G-002750	3803.0244

4.1.5 Available Accessories

Available accessories	Product number	Original number
MFS IP56 Kit	G-002628	3698.0016
MFM IP56 Kit	G-002629	3698.0018

4.2 Software Specifications

4.2.1 Supported NMEA Sentences IEC 61162

Supported NMEA sentences (IEC 61162)	
Primary IN	\$xxDPT
Secondary IN	\$xxDDC
Secondary IN	\$xxDBT
Secondary OUT	\$VDDDC

4.2.2 Indication List

Indication list	
Invalid checksum of NMEA ... sentence	Checksum of incoming sentence is incorrect
Parsing of NMEA ... failed	Contents of incoming sentence is incorrect
No depth message received	NMEA: Missing of correct Depth sentence (> 6 sec.)

4.3 Mechanical Drawings

4.3.1 Mechanical Drawing MFS-H

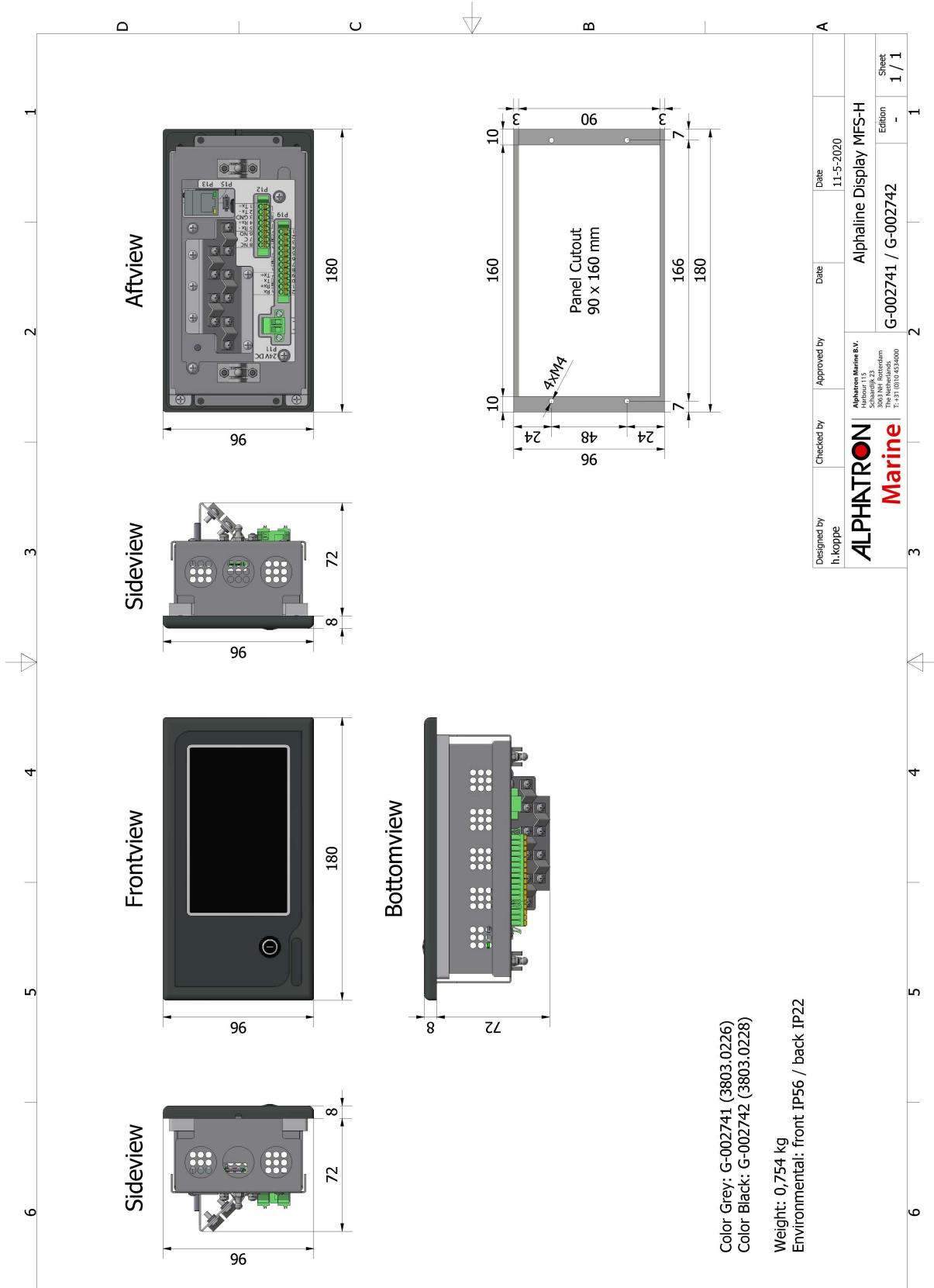

4.3.2 Mechanical Drawing MFM

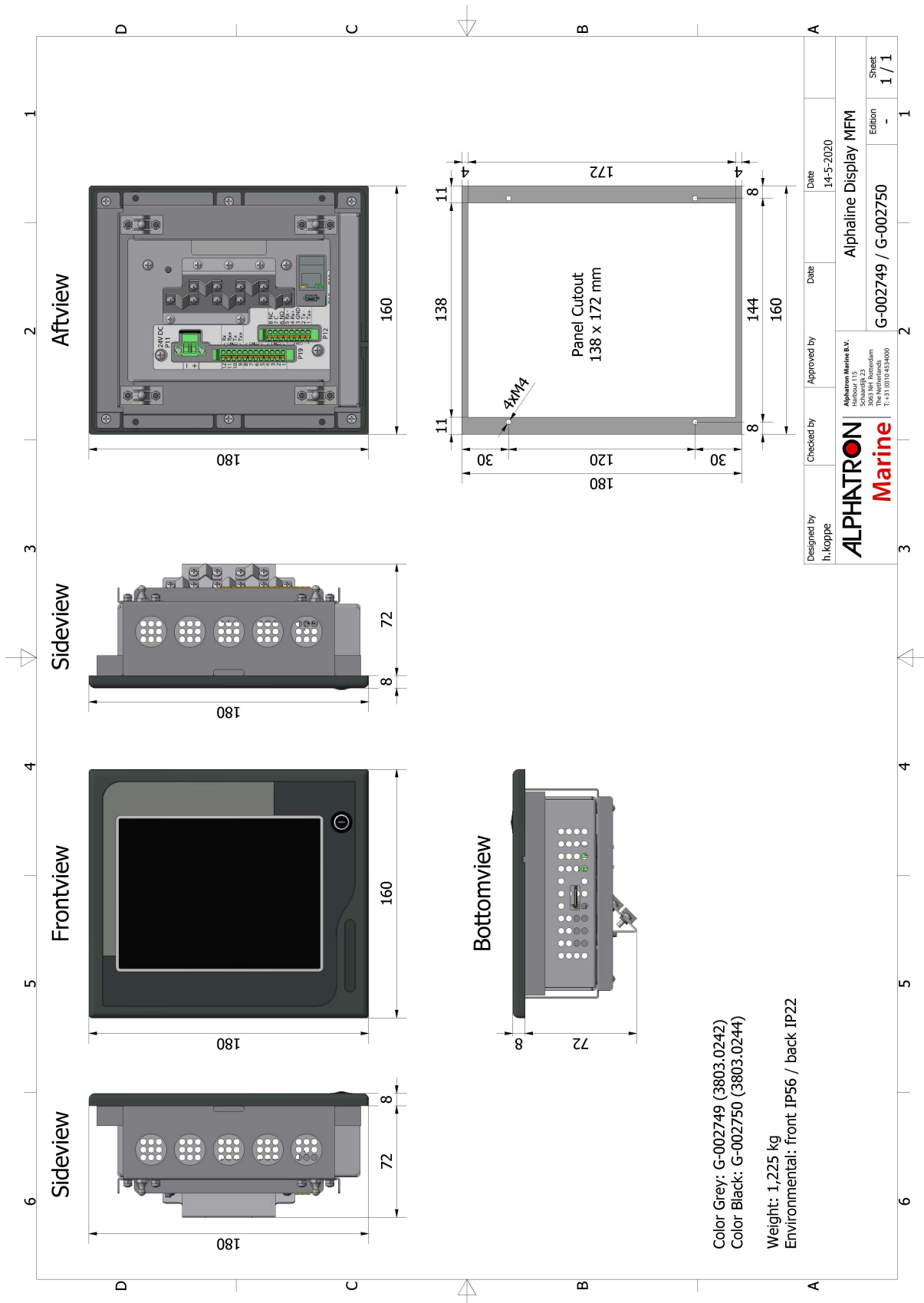

4.4.2 Connection Diagram AlphaDepth

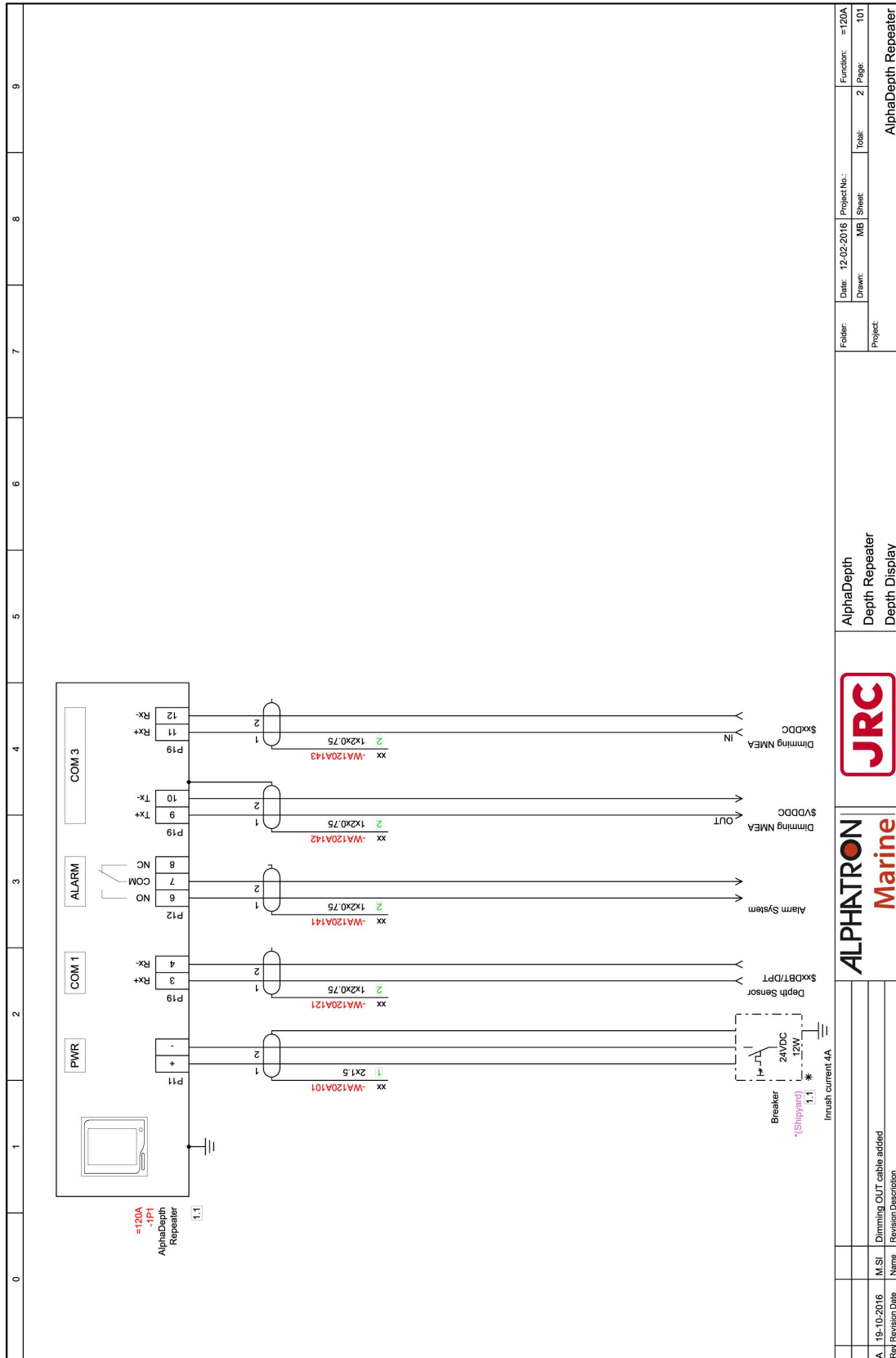

Rev	Revision Date	M.S.I	Name	Revision Description
A	19-10-2016	M.S.I	Dimming OUT cable added	

Folder:	Date:	Project No.:	Function:
MB	12-02-2016		= 120A
Drawn:	Sheet:	Total:	Page:
	2	2	101

Project:	AlphaDepth
Project:	Depth Repeater
Project:	Depth Display

4.5 Schematics

This chapter contains the schematics of the AlphaLine instruments. The commissioning engineer uses the schematics to be able to connect the signals according to the ship's requirements.

4.5.1 Schematics AlphaLine MF Display Unit

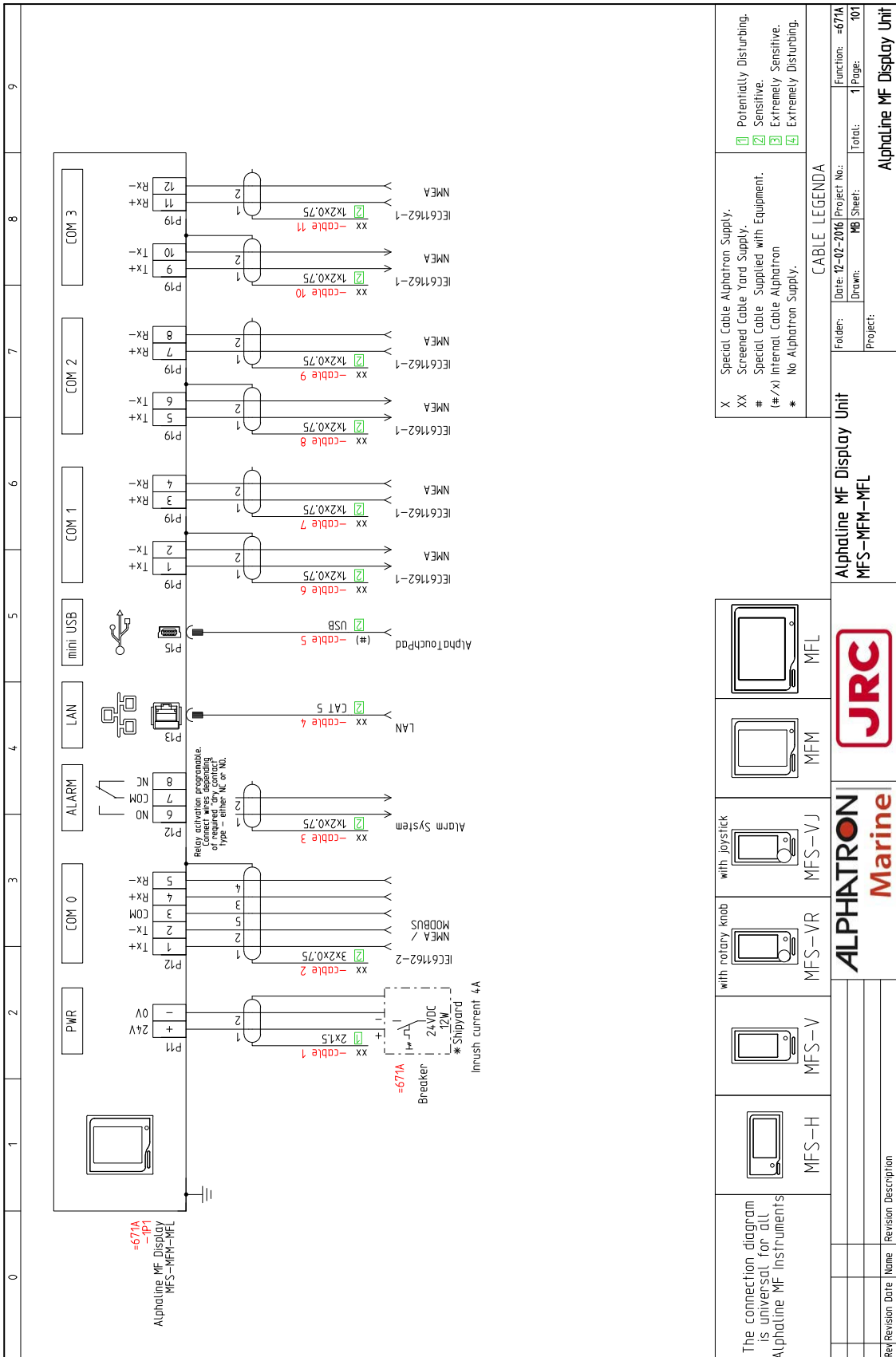

4.5.2 Schematics AlphaLine Instrument

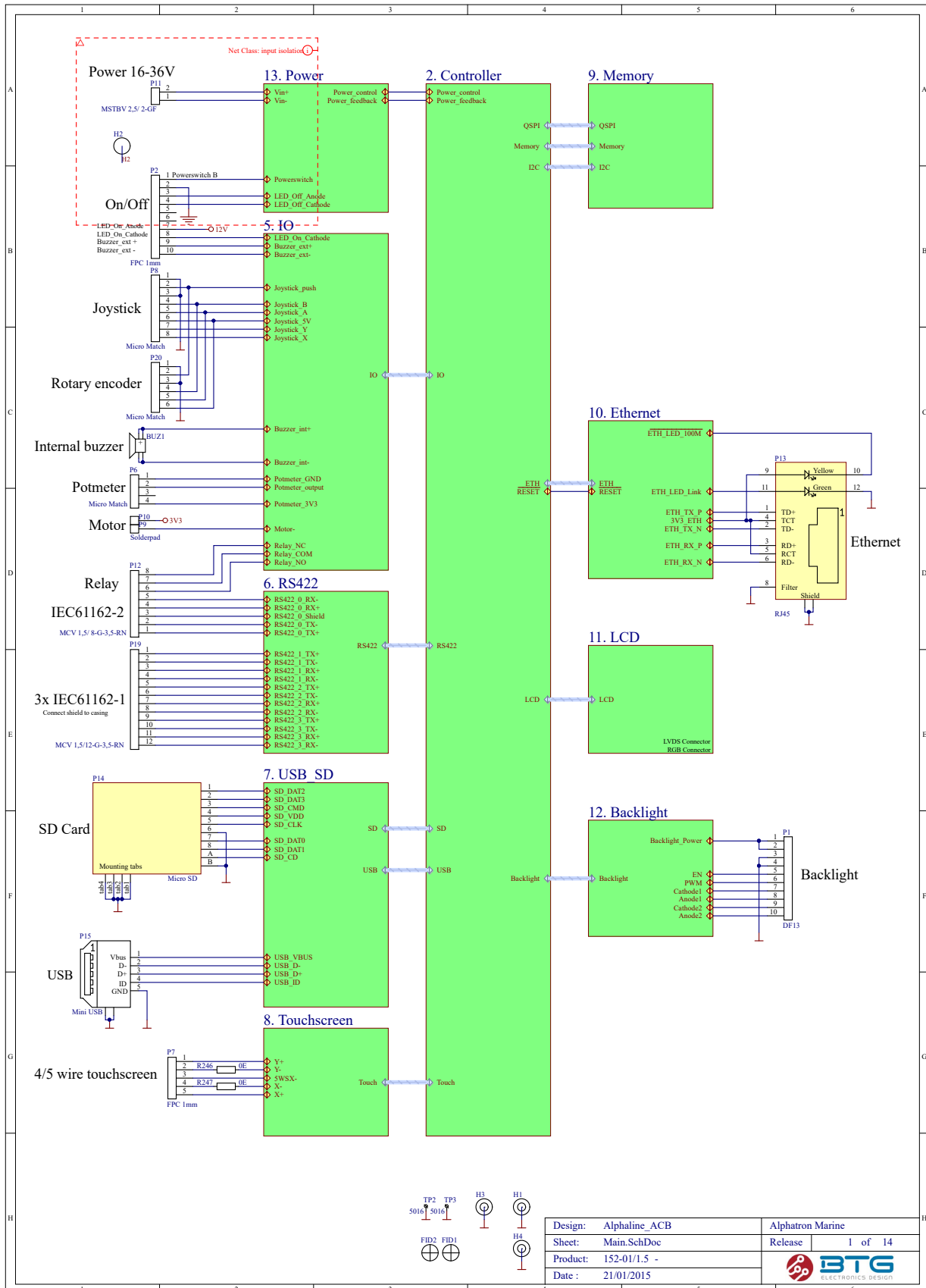

Design:	AlphaLine_ACB	Alphatron Marine
Sheet:	Main.SchDoc	Release 1 of 14
Product:	152-01/1.5 -	BTG ELECTRONICS DESIGN
Date:	21/01/2015	

All over the world,
close to the customer

JRC/Alphatron Marine B.V.

Schaardijk 23 (harbor 115)
3063 NH Rotterdam
The Netherlands
T +31 10 453 4000
F +31 10 453 4010
service@jrc-europe.com
www.jrc-world.com

The information in this document is subject to change without notice and does not represent a commitment on the part of Alphatron Marine B.V.

Document name : AlphaDepth
Document nr. : 1000_15
Version : V1.0.9
© All rights reserved Alphatron Marine B.V.

Centers of Excellence

Houston, Rotterdam, Singapore, Tokyo